



Instrument Training Guide

Model 991R-UFC



Florite International, Inc.
Model 991R-UFC Instrument Training Guide
Universal Flow Controller

1.0 PRODUCT INTRODUCTION

1.0.1 The System

The Model 991R is a versatile full-featured measurement and control instrument - with precision multiple ports and a channel capability. Its operating controls primarily support point-n-click navigation.

It supports independent full function input measurement ports and advanced technology output ports. Extensive local and remote information communication is provided.

Superior technology is combined with operating simplicity, versatility and ruggedness. The Model 991R is easy to install and operate. An extensive open architecture enables a wide range of special operating capabilities organized to meet the needs of nearly any high-accuracy precision measure, process, alarm monitoring and communication application requirements.

1.0.2 The Technology

The system is all digital based on microcomputer technology - no power switch to be left off, no feature selection switches or jumpers, no analog trimming potentiometers. Just all digital.

It employs surface mount technology and incorporates a powerful package of floating-point digital signal processing arithmetic. Built-in test capabilities enable simple installation, and extensive self-tests insures long term operating reliability. The rugged package is modular - and represents an ideal solution for use in demanding applications and tough environments. Mounting options are available for rack-panel, desk-top with support for various input and output signal types.

1.0.3 The Applications

This system suits applications requiring advanced multiple port and channel, supported by extensive integrated information communication capabilities. It services nearly all process and sensor signal measurements for manufacturing and batch processing, proportional blending, machine control, bio-medical pressure and temperature, chemical and pharmaceutical, laboratory, ecologic, agriculture, petroleum, heating and air conditioning, water filtration and purification, beverage and fluid delivery, automatic billing systems, asset accounting and service programs, performance tracking and verification, quality assurance programs, operations and maintenance management information gathering, regulatory compliance, liability mitigation, and public safety programs.

1.0.4 The Organization

The system has a port based architecture, modularly organized as independent ports, or ports combined as channels, to meet present and future instrumentation requirements.

The systems ports support universal input and universal output signal types. Ports may be intermixed to support an extremely wide variety of signal service requirements.

Input ports provide value measurements for quantity accumulation, rate measurements, scalar measurements, supported by value scaling for process frequency, pulse, voltage, current or resistance signals.

Independent value scaling and smoothing filters compensate for specific signal service requirements.

Signal acquisition uses digital signal processing to reject ambient noise and interference. Programmable excitation selections are available to power most sensors. Advanced signal output ports provide extremely stable voltages, currents, and supports isolated relay contacts.

1.0.5 Communication

The communication facilities provide data acquisition, command and control functions, and support information gathering and reporting, and alarm signaling. It has a built-in EIA-TIA232 standard interface.

Communication is initiated by command (solicited), alarms (unsolicited), and real-time scheduled reporting using its internal date-time clock.

1.0.6 Alarm Monitoring

Independent user-programmable alarm threshold limits are available for every measured value. Included in each port are two independent quantity accumulators, scalar value, process rate and service time. Alarms are programmable to activate local annunciation, local display alert, and drive relay or analog output, instigate local and remote computer communication.

1.0.7 Process Controls

Rate and batch delivery, control are readily achieved using either the front panel key controls or serial commands.

1.0.8 Operator Controls

The instrument has no power switch to be accidentally turned off. Operation may be completely controlled from its integral eight key pad used to view operation and programmed operation values. Key activations are single touch and repeat when the key is held. The key pad provides front panel splash proofing and environment protection.

1.0.9 Operator Indicators

The primary indicator is a large variable-brightness back lit liquid crystal graphic display - visible at a distance even in low light conditions for value viewing, programming, process state information, and alarm status. A built-in audio indicator annunciates alarm conditions and key activations.

1.0.10 Diagnostic Capabilities

Powerful automatic built-in tests support easy installation and ensure a long, trouble-free operating life. Tests include scans of all memory facilities, peripheral input-output status, communication adapter status, clock and data logging operation, keypad tests, and proper operation of the display and audio indicator.

1.1 TABLE OF CONTENTS

Section	Title
1.0	Product Introduction
1.0.1	The System
1.0.2	The Technology
1.0.3	The Applications
1.0.4	The Organization
1.0.5	Communication
1.0.6	Alarm Monitoring
1.0.7	Process Controls
1.0.8	Operator Controls
1.0.9	Operator Indicators
1.0.10	Diagnostic Capabilities
1.1	Table of Contents
1.2	Revision History
2.0	Installation
2.1	Signal Wiring
2.2	Accessories
3.0	Indicators
3.1	Normal home screen fields
4.0	System Controls
4.1	Navigate Controls
4.2	Operation Controls
5.0	Navigation
5.1	System Navigate Map
5.2	Menu Selection
6.0	Process Value Set-Points
6.1	PV Measures and SP Values
6.2	PV and SP Programming
7.0	Global Settings
7.1	Information Screen
7.2	System Power Control
7.3	Control Service Screen
7.4	Communication Screen
8.0	Process Controls
8.1	Rate Control (manual set-point)
8.2	Batch Control
9.0	Signal Calibration
9.1	Warranty Affectivity
9.2	Factory Confirmation

- 9.3 Equipment and Verification
- 9.4 Start Calibration Tool
- 9.5 Select Calibrate Signal
- 9.6 Calibrate Functions and Controls
- 9.7 Stop Calibration Tool

10.0 Serial Communication Protocol > Contact Florite

11.0 Product Specifications

12.0 Notices

- 12.1 Medical Alert
- 12.2 FCC Compliances
- 12.3 EU Compliances
- 12.4 Hazardous Wastes
- 12.5 Legal Notices

1.2 Revision History

Effective Date
04Jun2014

Revision Enhancement
1. Initial organization and documents assembly

2.0 Installation and Accessories

This section describes the various system electrical wiring requirements, and provides information on the various available mounting accessories including table top, panel and rack.

2.1 Signal Wiring

991R Signals and Wiring Installation

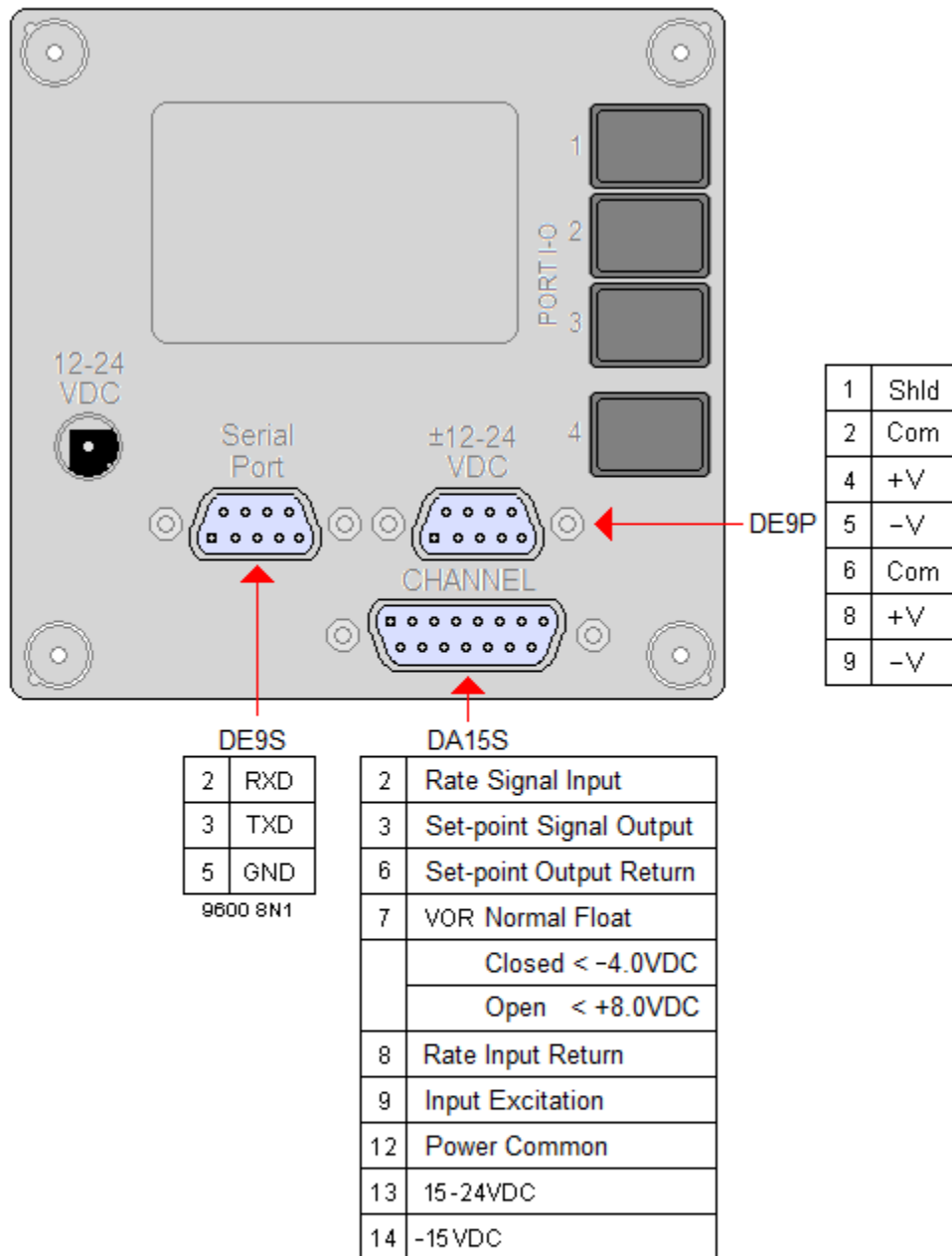

Florite International, Inc. warrants that every reasonable effort has been made to assure the accuracy of the information contained herein, however, assumes no responsibility for its use. The information is subject to change at any time without notice, and no part of it may be reproduced without prior agreement and written consent of Florite International, Inc.

991R PANEL CUTOUT

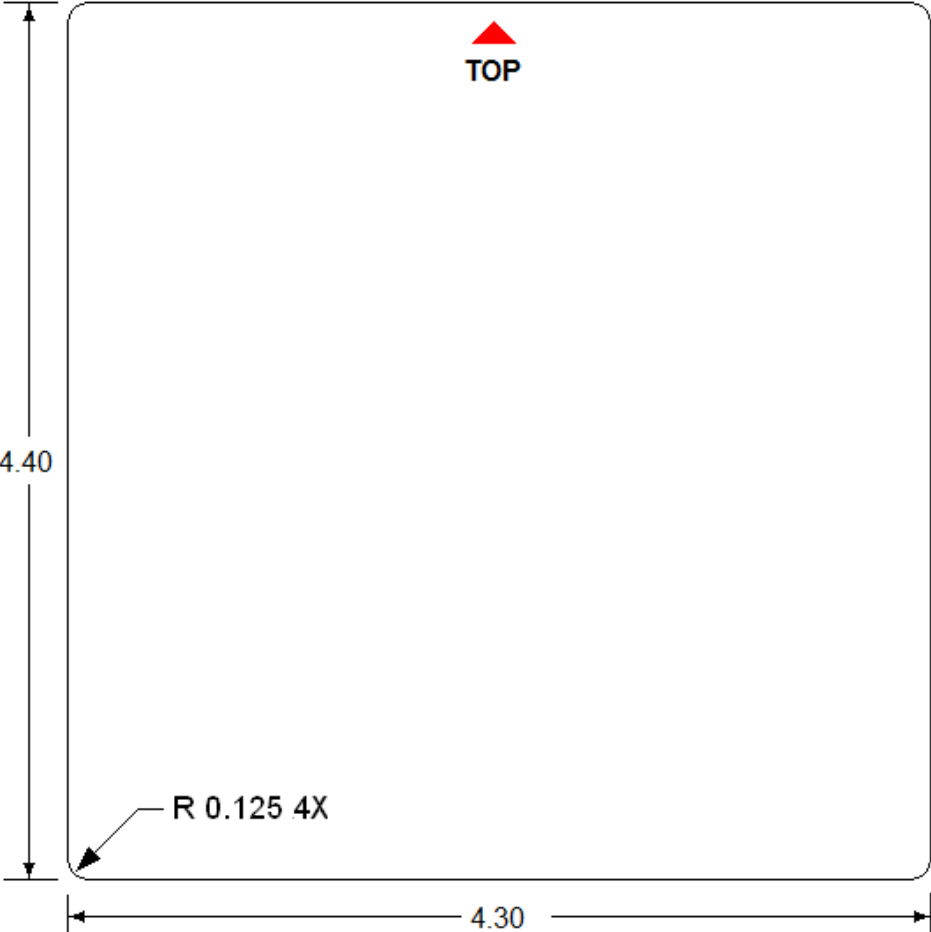

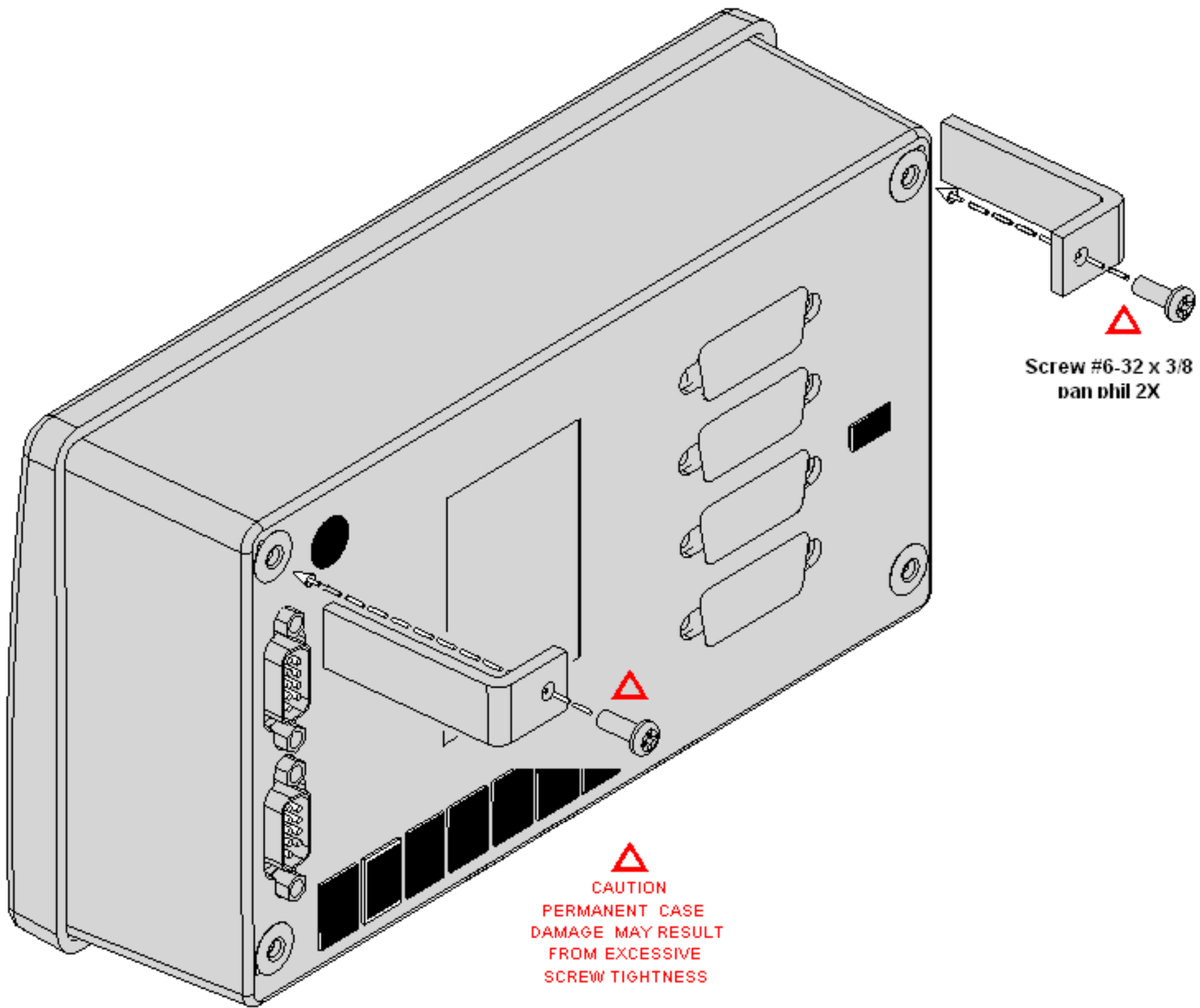

Screw #6-32 x 3/8
pan phil 2X

CAUTION
PERMANENT CASE
DAMAGE MAY RESULT
FROM EXCESSIVE
SCREW TIGHTNESS

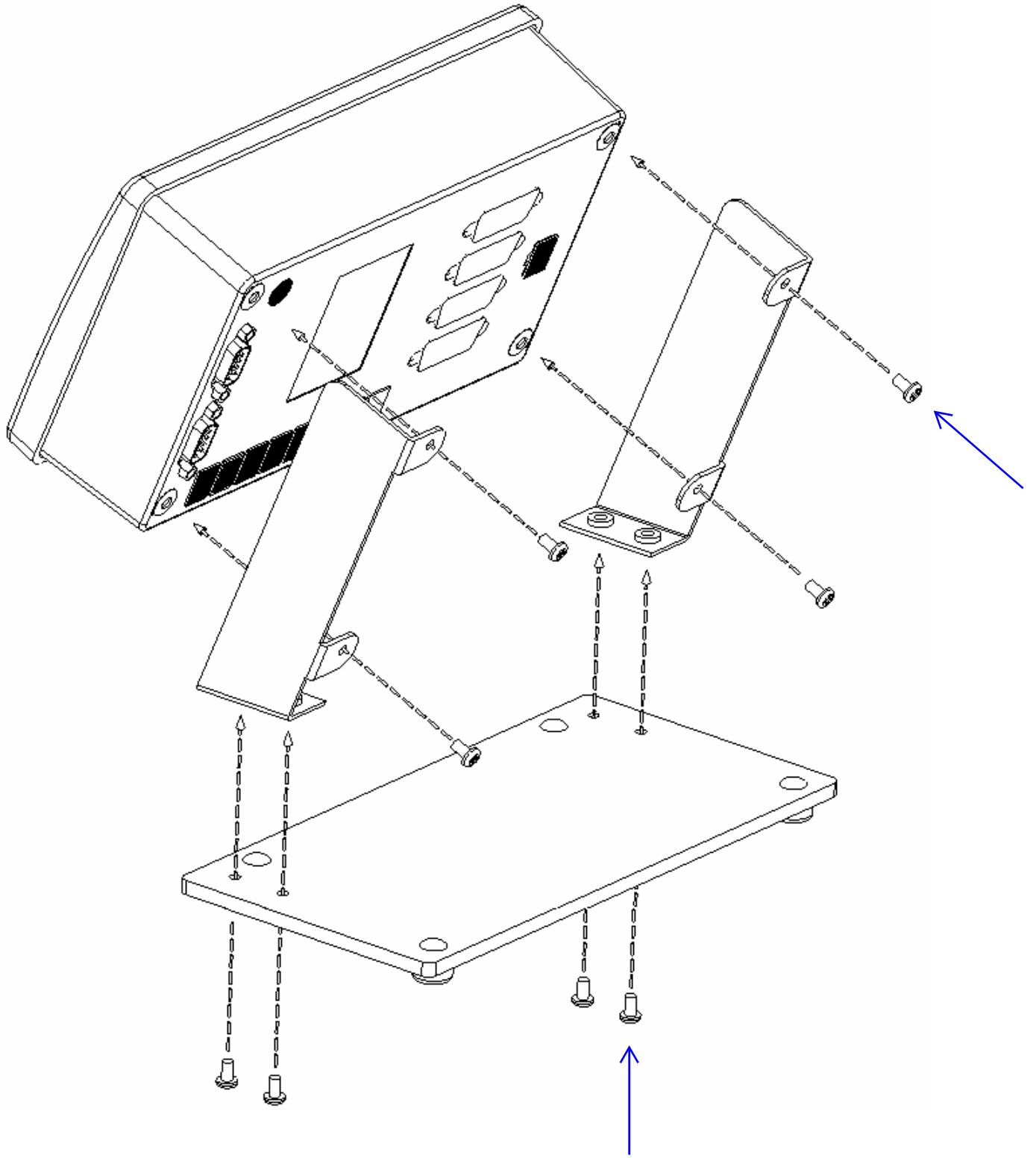

3.0 Indicators

The home screen is the instruments central information and navigation indicator. The home screen is presented following initial power application, and automatically follows the make-model screen banner. It provides an over-all view of instruments operation.

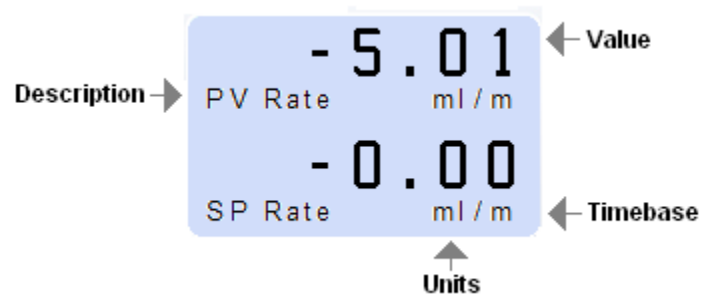

3.1 Display - home screen fields

3.1.1 Description - process value text

3.1.4 Value - numeric process amount



3.1.5 Unit / Time-base - combined measure units and rate time-base

4.0 System Controls

The primary instrument controls consists of eight front panel tactile snap-action keys - and a serial communication capability. Every function that can be accomplished by using the keys can also be accomplished by serial communication commands - the aspects of which are described in the Protocol section.











4.1 Navigation functions performed from the home screen are follows:

- 4.1.1 Select a channel using the  and  keys
- 4.1.2 Select a channel process value to be shown show on the home screen
- 4.1.3 Change the value of a channel program variable
- 4.1.4 Enter the Global System Settings selection menus
- 4.1.5 Quickly navigate to certain special values requiring frequent change
- 4.1.6 Start and stop control functions
- 4.1.7 Select a blend control master
- 4.1.8 Perform analog signal calibration

Instructions for the using the above are described in their respective sections.

4.2 The control function of the keys is dependant on the context of the function that has been requested to be accomplished as follows:

- 4.2.1  Home Screen - navigates to channel function screen
Port I-O Screen - selects view or program
View Screen - selects home screen value
Program Screen - programs value cursor points to - then saves the value
- 4.2.2  Home Screen - press 3X to enter Global System Settings
NOT Home Screen - navigates immediately to previous screen
- 4.2.3  Home Screen - press 3X to start batch and-or blend controls operation
Power Down - press to restore power
- 4.2.4  Home Screen - terminates operating controls if any - otherwise
HOT navigates to change channel VOR state.
- This key can be used to power-down the system when held depressed longer than three (3) seconds.
- 4.2.5  Cursor Control - move cursor up
Program Screen - increase blinking program selection to succeeding choice
- 4.2.6  Cursor Control - move cursor down
Program Screen - decrease blinking program selection to preceding choice
- 4.2.7  Cursor Control - move cursor left
Home Screen - select channel pointed to by cursor as blend master unless the channel is already the master in which case the existing master is deselected and no master is chosen
View Screen - zero PV Total when cursor points to PV Total
Program Screen - move blinking program selection to next left choice
- 4.2.8  Cursor Control - move cursor right
Home Screen - **HOT** navigates to change channel set-point value

5.0 Navigation

This navigation section provides an overview of the various values that are available to set-up desired operating characteristics that establish how the instrument is desired to perform, and to review the operating state of the desired performance.

Although navigation is described for keypad operation - the same operating characteristics set using the keypad are supported by serial communication - for which a detailed description is contained in the section 10.0 Serial Communication Protocol.

A complete system map is provided to support the overview of the instrument. It shows the entire organization of all of the instrument process values (PV), all set-point (SP) values, and all system global settings.

5.1 System Navigation 991R-MFC

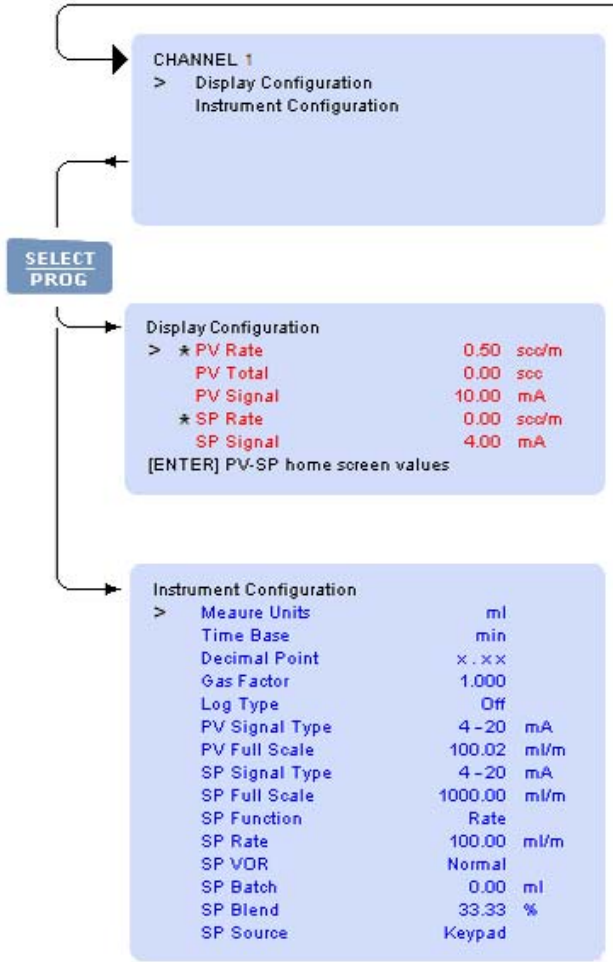
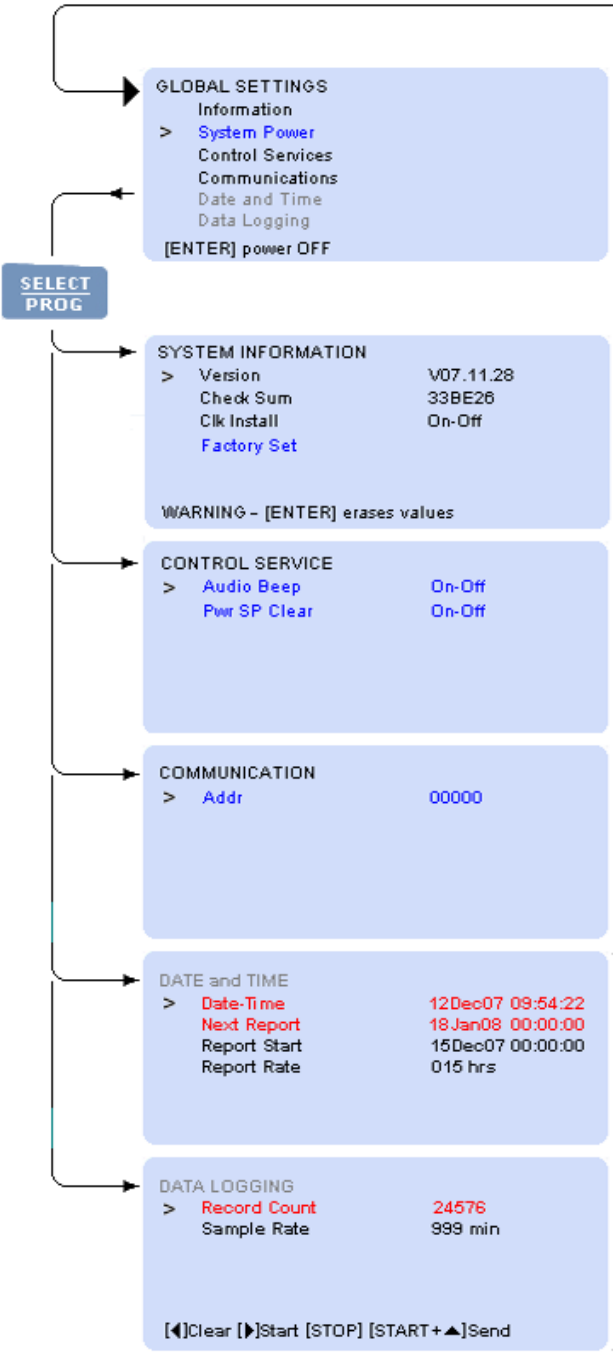
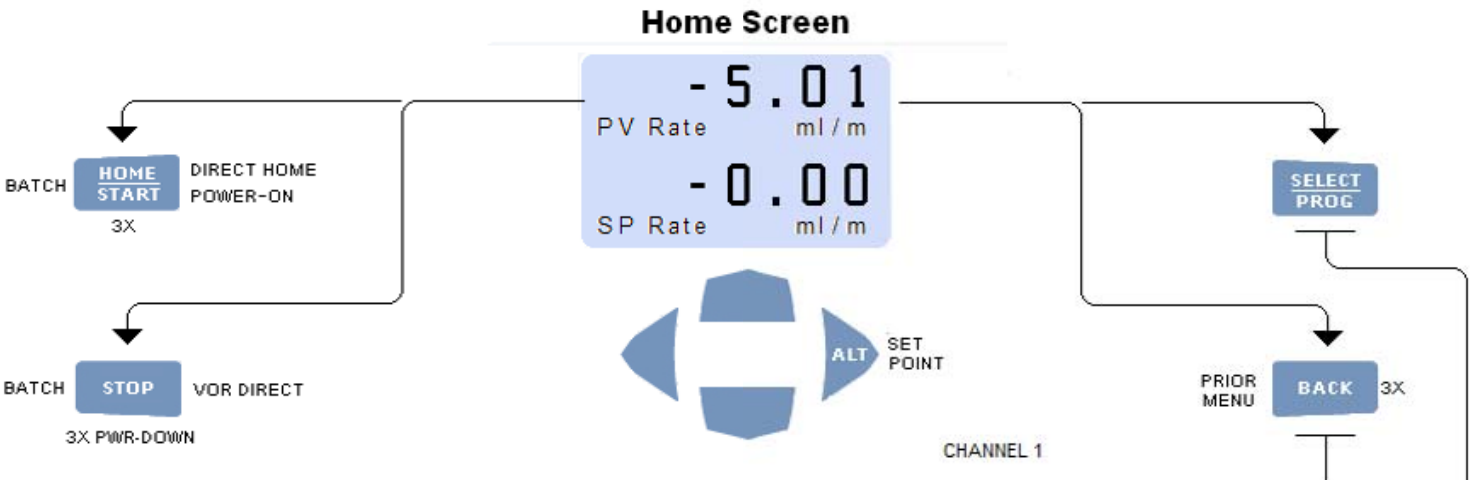

LEGEND

BLK	Static View	>	Cursor
RED	Dynamic View	M	Blend Master
BLU	Static Program	S	Blend Slave
GRY	Option	[]	Key Name
		B	Batch Channel
		*	Home View
		3X	Press 3 times

Flori International, Inc. warrants that every reasonable effort has been made to assure the accuracy of the information contained herein, however, assumes no responsibility for its use. The information is subject to change at any time without notice, and no part of it may be reproduced without prior agreement and written consent of Flori International, Inc.

All rights reserved © 2014

5.2 Navigate Select

The selection screen provides a secondary navigation layer for the operator to specify whether PV-SP Viewing (Display Configuration), or PV-SP Programming (Instrument Configuration) is desired for a channel. The screen shown below is displayed as a result of having pressed the [SELECT] key while viewing the home screen.

This screen shown is for Channel 2. Use the cursor keys to point to either Display Configuration to show the present PV Measurements and SP Status - or Instrument Configuration to program PV and SP values and then press [SELECT] to proceed to the desired selection.

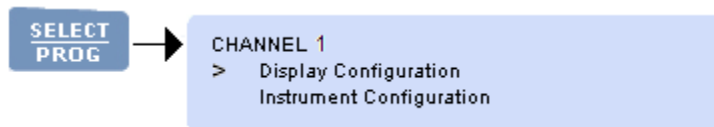

6.0 Process and Set-Point Values

This Process Values (PV) and Set-Point Values (SP) section provides a detailed description of the various system map values that are used to set-up the instruments desired operating characteristics that establish how the instrument is desired to perform, and discusses the various process values that show the operating state that are the outcome of the set-up.

6.1 PV MEASURES and SP STATUS VALUES

This section describes a combined screen for channel PV Measures and SP Status. It describes each of PV Measures and SP Status values for an input signal into the instrument, and output signal from the instrument.

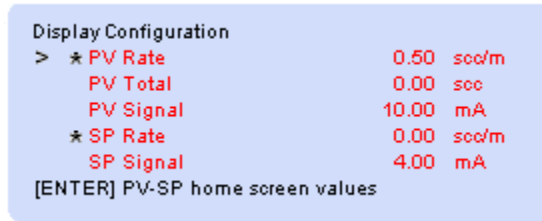

The screenshot shows a 'Display Configuration' screen with a list of parameters and their values. The parameters are: PV Rate (0.50 sco/m), PV Total (0.00 sec), PV Signal (10.00 mA), SP Rate (0.00 sco/m), and SP Signal (4.00 mA). A star (*) is next to PV Rate and SP Rate. A cursor (>) is next to PV Rate. At the bottom, it says '[ENTER] PV-SP home screen values'.

Parameter	Value	Unit
> * PV Rate	0.50	sco/m
PV Total	0.00	sec
PV Signal	10.00	mA
* SP Rate	0.00	sco/m
SP Signal	4.00	mA

6.1.1 Change Home Screen Value

The present PV and SP values shown on the home screen are indicated by a star (*) prefix. To change the PV displayed on the home screen - point the cursor to the desired PV value and press the [SELECT] key. To change the SP displayed on the home screen - point the cursor to the desired SP value and press the [SELECT] key. In both cases for PV and SP - note that the star indicator is now prefixed to a new PV or SP value.

6.1.2 PV Value Descriptions

6.1.2.1 PV Rate

This value is either a Rate, defined as quantity per unit time, or None, which is a scalar value not having a time associated attribute. Scalar measurements are not totalized. The value displayed is updated live as the value changes.

6.1.2.2 PV Total

This is a quantity accumulator for a rate value. The quantity values are displayed when the channel time base is NOT programmed for None. PV Total quantity is not accumulated for None values, and no PV Total will be shown on the screen. The value displayed is updated live as the value changes.

To clear an accumulated quantity to zero - point the cursor to PV Total and press the [◀] key. Note the value becomes zero.

6.1.2.3 PV Signal

This value is the measured electrical value being input into the instrument channel. It may be used to provide assistance in system installations, and is used to support instrument calibration. The value displayed is updated live as the value changes.

6.1.3 SP Value Descriptions

6.1.3.1 SP Set-Points

Separate set-points are provided for rate control (SP Rate), Batch quantity (SP Batch) and Blend proportion (SP Blend). The specific set-point shown on the screen is dependant on the SP Function control type that has been selected. The value displayed is updated live in real time as the value changes.

6.1.3.2 SP Signal

This value is the output signal being sent form the instruments channel, and is expressed in the appropriate analog signal type units of volts or mA.

6.2 PV and SP PROGRAM VALUES

This section describes the combined PV and SP programmable channel values. The programmed values determine how signal inputs into an instrument channel, and signal outputs from the instrument are serviced. Refer to the Control Functions section which describes in greater detail the set-up, operation and termination of control processes.

The PV and SP program values are used to determine basic channel fundamental attributes, gas type service, logging type, channel override signal, PV signal type and full scale range, SP signal type and full scale range, channel service function, channel override signal, SP set-point values, and SP programming source. The PV and SP values are static - and updated only after a value has been changed and saved.

6.2.1 Value Programming

6.2.1.1 Program a value by pointing the cursor to its line and pressing the [SELECT] key. Note a character or string (character-string) will be blinking - ready to be edited.

6.2.1.2 Edit the character-string as follows:

Change character-string to next value [▲] key - or previous value [▼] key

Move blinking character-string edit field left [◀] key - or right [▶] key

6.2.1.3 Edit completion

Press [SELECT] key to save the changed value - any other key causes the edited value to be ignored and not saved - and the original value to be edited will remain unchanged.

6.2.1.4 Edit Time Expired

When editing a character-field that is blinking - the program state will be terminated if a key is not detected within 30 seconds of the last detected key. In this case - the value edited will not be saved, and the original value to be edited will remain unchanged.

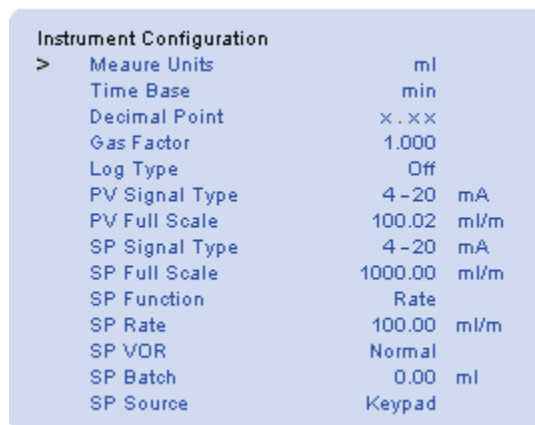

Instrument Configuration		
>	Measure Units	ml
	Time Base	min
	Decimal Point	x . x x
	Gas Factor	1.000
	Log Type	Off
	PV Signal Type	4 - 20 mA
	PV Full Scale	100.02 ml/m
	SP Signal Type	4 - 20 mA
	SP Full Scale	1000.00 ml/m
	SP Function	Rate
	SP Rate	100.00 ml/m
	SP VDR	Normal
	SP Batch	0.00 ml
	SP Source	Keypad

6.2.1 Measure Units

Measure units are a combination of symbols used to identify a physical engineering measurement. The measure units may be selected from a fixed set of customary strings. Measure Units have no arithmetic affect. Supported measure units are the following:

ml	mls	mln	l	ls	ln
cm ³	cm ³ s	cm ³ n	m ³	m ³ s	m ³ n
g	lb	kg	ft ³	ft ³ s	ft ³ n
scc	sl	bar	mbar	psi	kPa
Torr	atm	Volt	mA	oC	oK
oR	oF	g/cc	sg	%	lb/in ³
lb/ft ³	lb/gal	kg/m ³	g/ml	kg/l	g/l

6.2.2 Time Base

This selection is used to set the quantity per unit time rate measurement base as either Sec, Min, Hrs, or Days. The None time base selection is presumed not to have a time-quantity association and does not perform quantity accumulation.

6.2.3 Decimal Point

The decimal point for values may be freely selected for none, one, two, or three places. The decimal sets the number of measurement value digits that are to the right of the decimal point. Setting the decimal has an arithmetic function that when changed - automatically multiplies or divides an existing value so values continue to retain their power-of-ten value. The values so affected include PV and SP Full Scale, SP Rate, SP Batch.

6.2.4 Gas Factor

This value is a unit-less factor by which measured PV Signals are compensated by multiplication, and SP Signals corrected by division. This instrument performs the arithmetic compensation using the Gas Factor.

This capability makes it possible to compensate other gasses which are not the calibration gas - however, the existing Gas Factor must be known and then methodically changed. By knowing the present factor for the calibration gas, and desiring to control known gasses for which the TMF has not been calibrated, then just divide the [new gas factor] by the previously known [calibrated gas factor]. The result becomes the new Gas Factor.

6.2.6 PV-SP Signal Types

6.2.6.1 Signal Selections - may be set for full scale ranges which include 0-20mA, 4-20mA, 0-5V, 1-5V, 0-10V 2-10V or OFF.

6.2.6.2 The OFF selection suspends service for either or both channel PV and/or SP signals. Inactive OFF is indicated on the home screen as a blank line.

When either or both the PV or SP parts of a channel are set to OFF - the instrument remembers the active type(s) prior to having been set to OFF. This enables the instrument to continue with the same PV and-or SP type that existed before being set to be OFF when returned to the On state. This insures that the factory installed hardware module configuration in the instrument continues to remain properly operable.

6.2.7 PV-SP Full Scale

This value sets the maximum engineering unit range over which the Signal Type is valid. The minimum is always presumed to be zero. Full-Scale values are bipolar and are required to be set for positive values for control functions to perform correctly.

6.2.8 SP Function

The allowable set-point Functions are Rate, Batch or Blend. Set-point values are bipolar and are required to be positive values for correct control function performance.

6.2.8.1 Rate

This control type ignores the channel PV Rate. The value set in the SP Rate register is de-interpolated to a corresponding analog signal which is directly sent to the channel analog signal output.

6.2.8.2 Batching

Batching is a discontinuous control process that delivers the quantity set in the SP Batch register. This process is started using either the keypad or a serial communication command. Batching is terminated when the desired batch quantity has been delivered - or any time before delivery is complete by pressing the [STOP] key .

6.2.9 SP VOR

This value is set to Normal for standard TMF operation. VOR Normal causes a VOR signal output voltage to be disconnected - floating. The VOR function is used in TMF applications to override the normal analog command signals, and finds use for installation and system diagnostic purposes.

6.2.9.1 Valve Open

The VOR output signal is connected and provides a voltage $> 8.0\text{vdc}$ causing the TMF valve to be fully open.

6.2.9.2 Valve Closed

The VOR output signal is connected and provides a voltage $< -4.0\text{vdc}$ causing the TMF valve to be fully closed.

6.2.10 SP Source

This control enables selection of the source from which set-points may be entered as either Keypad or Serial. When set for Serial - changing a set-point using the keypad is prohibited.

7.0 Global Settings

This section provides a detailed description of the various system wide variables used to set-up and review the overall operating characteristics that establish how the entire instrument is desired to perform. The values include those provided only for review, those that can be selected, and those that invoke immediately action.

7.1 Information Screen

To enter the information service screen - point the cursor to Information on the Global Settings screen and press the [SELECT] key.

```
GLOBAL SETTINGS
  Information
  > System Power
  Control Services
  Communications
  Date and Time
  Data Logging
[ENTER] power OFF
```

This screen contains system information values and configuration states. These values are not programmable, with the only exception being the Factory Set immediate action selection described below which erases present programmed values and replaces them with factory default values.

```
SYSTEM INFORMATION
  > Version          V07.11.28
  Check Sum         33BE26
  Clk Install       On-Off
  Factory Set
WARNING - [ENTER] erases values
```

7.1.1 Version

This is the date the firmware was last upgraded represented as year, month and day, and is only for review.

7.1.2 Check Sum

This value is the hexadecimal double word sum of the instruction read only memory used for factory quality assurance, and is only for review.

7.1.3 Start Vector

This is the address in hexadecimal at which the firmware begins operating following a power-up reset, and is only for review.

7.1.4 Clk (Clock) Install

This state indicates whether the real time clock is installed and operating which is detected immediately after a power-up reset. The clock is used for scheduling data or log reports, and for date-time stamping logged records.

7.1.5 Factory Set

When the cursor is pointing to Factory Set, a pop-up warning displays "WARNING - [SELECT] erases program values" at the bottom of the display. Pressing [SELECT] will cause all user program values to be immediately erased and over-written with factory standard default values. Factory Set does NOT erase factory pre-set calibration values which continue to be retained.

7.2 System Power Control

To enter the System Power function - point the cursor to System Power on the Global Settings screen and press the [SELECT] key. This is an immediate action selection.



7.2.1 System Power

The System Power functions allows the user to cause power to equipment connected to the instrument to be placed in an Off state, allowing the user to conduct installation services and diagnostics. The power off state is also useful for placing the instrument and connected equipments in an un-powered state when the instrument is expected to remain unused for extended periods.

7.2.1.1 The pop-up at the bottom of the display is shown on the screen only when the cursor is pointing to System Power.

7.2.1.2 Power OFF - press the [SELECT] key with the cursor pointing to System Power. This will cause entry into the power down state, the screen to become blank with its back-light off, and all signals and power to be removed from connected equipment.

7.2.1.3 Power ON - press the [START] key to restore normal system operation.

7.3 Control Service Screen

To enter the Control Services screen - point the cursor to Control Services on the Global Settings screen and press the [SELECT] key.

```
GLOBAL SETTINGS
  Information
  > System Power
  Control Services
  Communications
  Date and Time
  Data Logging
  [ENTER] power OFF
```

These Control Service settings are programmable but are not live updated. They establish operation of the several system level operating controls.

```
CONTROL SERVICE
  > Audio Beep           On-Off
  Pwr SP Clear         On-Off
```

7.3.1 Audio Beep

When this control is selected ON - allows normal audio annunciation for alarms and key activation - otherwise all audio indications remain disabled.

7.3.2 Pwr SP Clear

When this control is selected ON - power restoration causes every channel SP value to be erased and made zero.

7.4 Communications Screen

To enter the Communications service screen - point the cursor to Communications on the Global Settings screen and press the [SELECT] key. The communication variables are programmable selections.

```
GLOBAL SETTINGS
  Information
  > System Power
  Control Services
  Communications
  Date and Time
  Data Logging
[ENTER] power OFF
```

The Communications settings are programmable and are used to establish the instruments communication parameters that control the systems three serial ports to send alarm, log, or data reports. The communication parameters are not live updated.

When the DATE and TIME clock is not installed - only the Network Addr (address) is shown on the service screen.

```
COMMUNICATION
> Addr           00000
```

7.4.1 Network Address

This address is a unique identification for the instrument operating in a network environment. It is factory pre-set to the unit serial number and is not customer programmable.

8.0 Process Controls

This section provides a detailed description and operation of the instruments various control functions.

8.1 Rate Control

Rate control is a continuous manually oriented process - performed on a channel-by-channel basis. This control type causes an SP Rate signal programmed by the operator to be output to a controller. Independently - the controller delivery rate signal is monitored separately and indicated as the channel PV Rate.

Instrument Configuration		
> Measure Units		ml
Time Base		min
Decimal Point		x . x x
Gas Factor		1.000
Log Type		Off
PV Signal Type	4-20	mA
PV Full Scale	100.02	ml/m
SP Signal Type	4-20	mA
SP Full Scale	1000.00	ml/m
SP Function	Rate	←
SP Rate	→ 100.00	ml/m
SP VOR		Normal
SP Batch		0.00 ml
SP Source		Keypad

8.1.1 Set-Up

The operator programs values shown above for each channel desired to perform Rate control.

8.1.1.2 SP Function - select Rate

8.1.1.1 SP Rate - desired delivery rate

8.1.2 Start Rate Control

This control type is continuous - requiring no start action to be taken by the operator.

	- 5.01	←
PV Rate		ml / m
	- 0.00	
SP Rate		ml / m

The delivery process can be monitored as shown on the live update screens above and below, observing that the SP Rate is the same as the monitored PV Rate.

Display Configuration		
> * PV Rate	0.50	sec/m ←
PV Total	0.00	sec
PV Signal	10.00	mA
* SP Rate	0.00	sec/m ←
SP Signal	4.00	mA

[ENTER] PV-SP home screen values

8.1.3 Terminate Rate Control

When the operator sets the channel SP Rate to zero - the process is off.

8.2 Batch Control

Batch processing is a non-continuous process that is started, conducted, and terminated when a desired quantity has completed delivery. The operator may stop batch delivery at any time prior to completion.

Instrument Configuration		
>	Meaure Units	ml
	Time Base	min
	Decimal Point	x . x x
	Gas Factor	1.000
	Log Type	Off
	PV Signal Type	4-20 mA
	PV Full Scale	100.02 ml/m
	SP Signal Type	4-20 mA
	SP Full Scale	1000.00 ml/m
	SP Function	Batch ←
	SP Rate	→ 100.00 ml/m
	SP VDR	Normal
	SP Batch	→ 0.00 ml
	SP Source	Keypad

8.2.1 Set-Up

The operator programs values shown above for each channel desired to perform batch delivery.

8.2.1.2 SP Function - select Batch

8.2.1.1 SP Rate - set desired batch delivery rate

8.2.1.3 SP Batch - set desired delivery quantity

8.2.2 Start Batch

8.2.2.1 Return to home screen - note home screen indicates a 'B' control indicator for all channels selected to perform batching.

	- 5.01	←
PV Rate	ml / m	
	- 0.00	
SP Rate	ml / m	

8.2.2.2 Press [START] key three (3) times - and note 'B' indicators now blinking to indicate channels with batch now in process.

8.2.2.3 The delivery process can be monitored as shown on the screen below observing that the PV Total increases toward the SP Batch amount, and verifying that the PV Rate properly indicates the desired delivery rate. The screen below is updated real-time live. Since the SP Function was set for Batch - the SP Batch quantity appears on this screen.

Display Configuration		
>	* PV Rate	0.50 scc/m
	PV Total	0.00 scc ←
	PV Signal	10.00 mA
	* SP Rate	0.00 scc/m ←
	SP Signal	4.00 mA
[ENTER] PV-SP home screen values		

8.2.3 Terminate Batches

8.2.3.1 Batching for each channel set for batch will automatically terminate when each batch channel PV Total has reached or exceeded their programmed SP Batch set-point.

8.2.3.2 The operator may terminate any channels that continue with batching remaining in process by first returning to the home screen, then pressing the [STOP] key once. Note that the 'B' control indicators on the home screen stop blinking indicating that all batch processes are stopped.

9.0 Signal Calibration

WARNING - EXPERTS ONLY **Incorrect Calibration Will Cause Defective Operation**

This section describes the operation of the various manual signal calibration functions. The purpose of calibration is to adjust the PV and SP signals to be in agreement with secondary standards. The calibration tool is invoked by the operator to become actively supplementary, and co-resident, operating simultaneously along with all other normal instrument functions.

Calibration is performed for the channel to which the home cursor is pointing. The channel selected for calibration may be changed to another channel at any time. The tool employs a dual-key methodology to cause operation of the desired calibrate function. Support is included to enable laboratory calibration to secondary standards of the National Institute of Standards.

9.1 Warranty Affectivity

The various calibrate functions may be useful by field personnel to achieve support for special installation requirements or verifications; however, should non-factory calibration be conducted - it will be detected by the instrument, and result in the instrument becoming ineligible to receive factory warranty calibration service.

9.2 Factory Confirmation

A factory conformance document may be serially sent from the instruments RS232 port using the front panel keys shown below in Fig 9.2a. The serial data may be viewed on-screen of a computer running a suitable serial communication program set to receive American Standard Code for Information Interchange (ASCII), 8 bit characters sent at 9600 bits per second, no parity, with at least one stop bit. The confirmation is pre-formatted with comma-delimits enabling direct import into Microsoft Excel™, or most other such data base programs.



Fig 9.2a

```
Title : Conformance                Standard : Agilent 34401A
Format: V(+/-0.004) mA(+/-0.015)  Cal Agent: factory
Serial: 11194
Model  : 0251

CH 1
, 0.000, 0.501, 1.000, 2.000, 3.001, 4.000, 5.000
, 0.000, 0.998, 4.997, 8.998, 15.001, 18.000, 20.002
```

Fig 9.2b

The numeric data for the various channels, shown in Conformance Fig 9.2b, are the factory analog calibration value results from looping the SP output to the PV input while being verified against the indicated standard instrument. The calibration conformance data is permanently retained in the instrument, and may not be edited or deleted. The "Cal Agent" entry indicates the most recent

calibration authority that has modified any of the instruments calibrate coefficient values - indicated either as "factory" or "non-factory".

9.3 Calibration Equipment and Verification Requirements

A standard measurement instrument shall be selected to meet accuracy and precision measurement requirements insuring that such measurements are acceptably valid.

9.3.1 Accuracy

Accuracy is the measure of the degree to which measurements are compared to a standard. The standard verify-calibrate instrument shall be manufacturer specified to perform with an accuracy two (2) times greater than the measured value required to be verified-calibrated. The standard shall have been calibrated to such accuracy by a third party laboratory certified to conduct such calibrations, and be within the standard instrument manufacturer's specified calibration period.

9.3.3 Precision

Precision is the degree to which a measurement is made which is a count of the number of decimal digits meant to represent the measurement. The standard verify-calibrate instrument incorporate inherent precision ten (10) times greater than the measured value required to be verified-calibrated. This application of standard engineering practice insures digital truncate<or>rounding by the standard instrument do not contribute adverse errors that would otherwise be presumed as an inaccuracy attributable to the devise being verified. Standard instrument manufacturers manual documents specify truncate<or>rounding limitations.

9.3.4 Verification Rounding

Engineering standard rounding techniques shall be employed to compensate verify-calibrate measurements by the standard instrument which adjusts the magnitude of the digit immediately right of the verification least significant digit (LSD). Such compensation shall increase the measured LSD value by one (1) when the standard digit immediately right of the required LSD indicates a value of five (5) or greater. Otherwise the LSD shall be the standard instrument measured value.

9.4 Start Calibration Tool

To start the manual calibrate tool - the operator simultaneously depresses both keys highlighted in red, shown in Fig 9.4a, EXACTLY five (5) times, with less than 2 sec between consecutive depressions. The tool is active when "Cal" appears in the top-right position of the display as shown in Fig 9.4b.



Fig 9.4a

1	PV Rate	444.99	scc/m	Cal
	SP Rate	445.00	scc/m	
> 2	PV Rate	32.49	scc/m	
	SP Rate	32.50	scc/m	
3	PV Rate	8950.50	scc/m	
	SP Rate	8949.00	scc/m	
4	PV Rate	10.00	scc/m	
	SP Rate	9.95	scc/m	

Fig 9.4b

9.5 Select Calibrate Signal

Analog milliamp (mA) and volt signals are supported. The signal type may be changed at any time.

9.5.1 Calibrate mA Signals - depress the keys shown highlighted in red on Fig 9.5.1a. Note the display will appear approximately as shown in Fig 9.5.1b.



Fig 9.5.1a

1	PV Signal	0.000 mA	Cal
	SP Signal	0.000 mA	
> 2	PV Signal	20.000 mA	
	SP Signal	20.000 mA	
3	PV Signal	0.000 mA	
	SP Signal	0.000 mA	
4	PV Signal	0.000 mA	
	SP Signal	0.000 mA	

Fig 9.5.1b

9.5.2 Calibrate Volt Signals - depress the keys shown in Fig 9.5.2a. Note the display will appear approximately as shown in Fig 9.5.2b. PV Signal and Vcomp signals are simultaneously calibrated.

The home screen display is observed to alternate every two seconds between indicating one of two volt input values shown as "PV Signal" and "Vcomp". "PV Signal" is the primary PV channel measurement - with the "Vcomp" signal being the Return signal, equal for both Rate Return and Command Return.

The Return "Vcomp" signal enables measuring voltage drop occurring between the power supply and the powered instrument, and are used to resolve the actual PV and SP volt signals.

It is required that both the PV and Return signals be equal during offset and span calibration, and the operator observes and compares both signals verifying they are equal to within ± 1 least significant digit.



Fig 9.5.2a

> 1	PV Signal	10.000 V	Cal
	SP Signal	10.000 V	
2	PV Signal	0.000 V	
	SP Signal	0.000 V	
3	PV Signal	0.000 V	
	SP Signal	0.000 V	
4	PV Signal	0.000 V	
	SP Signal	0.000 V	

Fig 9.5.2b

9.6 Calibrate Functions and Controls

Calibrating a PV (input) signal is fundamentally different from calibrating a SP (output) signal - besides the fact that the two signals go different directions with respect to the instrument. Calibration service is available for each channel for zero offset and full scale over analog ranges of 0-20.000 mA, and 0-10.000 volts.

9.6.1 PV - Input Signals

These signals are calibrated by presenting a signal to the input - then pressing appropriate keys that instruct the instrument to capture and interpret the observed signal as either offset or span. These are quick-cal processes.

9.6.1.1 PV Signal Offset

Connect no signal to the PV input. Depress the keys shown Fig 9.6.1.1a. Note on the home screen that the PV Signal value becomes zero confirming the calibration was successful.

9.6.1.2 PV Signal Span

Connect a 5.0000 volt <or> 20.0000 mA signal to the PV input. Depress the keys shown in Fig 9.6.1.1b. Note on the home screen that the PV Signal value becomes either 5.000±0.001 volt <or> 20.000±0.002 mA confirming the calibration was successful.



Fig 9.6.1.1a



Fig 9.6.1.1b

9.6.2 SP - Output Signals

These signals are calibrated by presenting their signal to the standard measurement instrument - then pressing appropriate keys that instruct the instrument revision to modify appropriate coefficients that change the present value up or down to a new value. These are tweak processes.

9.6.2.1 SP Signal Offset

Connect the SP output to the standard instrument set either to volts or mA as appropriate. Using the keys of Fig 9.6.2.1a below, press the BACK and UP keys to increase the output value, or BACK and DOWN keys decrease the output value. The calibrate value for volts is zero, and for mA is 0.2000 accordingly.



Fig 9.6.2.1a

9.6.2.2 SP Signal Span

Connect the SP output to the standard instrument set either to volts or mA as appropriate. Using the keys of Fig 9.6.2a below, press the BACK and UP keys to increase the output value, or BACK and DOWN keys decrease the output value. The calibrate value for volts is 5.0000, and for mA is 20.0000 accordingly.



Fig 9.6.2a

9.7 Stop Calibration Tool

Termination deactivates the calibrate tool operation which may be accomplished in several ways.

9.7.1 Keypad Terminate

Depress both of the highlighted red keys of Fig 9.3.1 below at the same time. This action causes the "Cal" indicator in the upper right corner of the home screen display to disappear indicating that the calibrate tool has been deactivated.



9.7.2 Power Off Terminate

Place instrument in the Power Down state by either of the following:

9.7.2.1 Enter Global Configuration, scroll down to "System Power" and depress the [ENTER] key, or

9.7.2.2 Depress the [STOP] key consecutively three times.

When the instrument is in the "Power Down" state - it may be restored to normal operation by depressing the [START] KEY. Note that when Power is restored - the home display is restored and the "Cal" indicator is no longer present.

9.7.3 Power Disconnect Terminate

Remove and then re-apply power to the instrument by removing the power plug from the rear apron. The calibrate state is not remembered - so on power re-application - the calibrate function is no longer active.

10.0 Serial Communication Protocol

For more information on the Model 991R serial communication protocol please contact Florite.

Florite International, Inc.

O: 818-994-3454

F: 818-994-3704

support@florite.com

www.florite.com

Technical Specifications

Control Functions	Rate, Batch	Process Rate	0.000±999,999 unit/time-base
Measure Type	Rate-Total, Scalar	Totalize Range	0.000 to 999,999 units
Process Input	Volt, mA	Process Output	Volt, mA
Programmable Values			
Channel Ranges	Off, 0-20mA, 4-20mA, 0-10V, 2-10V, 0-5V, 1-5V		
Measure Units	ml, mls, mln, l, ls, ln, cm ³ , cm ³ s, cm ³ n, m ³ , m ³ s, m ³ n, g, lb, kg, ft ³ , ft ³ s, ft ³ n, scc, sl, bar, bar, psi, kPa, Torr, atm, Volt, mA, oC, oK, oR, oF, g/cc, sg, %, lb/in ³ , lb/ft ³ , lb/gal, kg/m ³ , g/ml, kg/l, g/l		
Network Address	0-65,535		
Global Settings			
Display	Instrument Information, System Power (on/off), Control Services, Communication, Data/Time, and Data Logging		
Keypad	Graphic, backlit, LCD 8x20		
Audio	8-key metal dome tactile 2.0 KHz, 85db @ 10 cm		
Channel Interface			
Input			
	Interface	DA15S	
	Analog Voltage	0-10.000 V ±0.075% Zi-10.0K sense compensated	
	Analog Current	0-20.000 mA ±0.075% Zi 100 ohm	
Output			
	Interface	DA15S	
	Analog Current	0-20.000 mA ±0.075% Zo-inifinate sourcing	
	Analog Voltage	0-10.000 V ±0.024% Zo-1.0 ohm sense compensated	
	VOR Control	-4.0 to +8.0V @ -/+4.0mA max	
	TMF Power Control	Dual 24V at 2.0A	
Serial Port	EIA-TIA232D full duplex D9S Load 4.7K max standard		
Value Memory	Non-volatile ram 8Kx8 Non-volatile eeprom parallel 100 yr retention 512x8 Non-volatile eeprom serial 100 yr retention 256Kx8 Static ram parallel 1Kx8		
Self Diagnostics	Memory checksum, installation, local and remote serial communication		
Power Required	12-24 VDC 65-33 mA 0.8w		
Jack Unipolar	2.1 mm 2A center pos UL/CSA		
Plug Bipolar	DE9P 5A rated UL/CSA		
Consumption	2.0 watts		
Operating Environment			
Operation	0-55°C 0-95% RH non-condensing		
Ship-Storage	-20° to +85°C 0-95% RH non-condensing		
Warm Up	1 min typ to rated accuracy		
Enclosure			
Mounting	Panel, Desk Top, Rack and Cassette		
Panel Cutout Size	4.407 x 4.275 (4X R0.125)		
Material	GE Cyclocac Resin FR23, PBB, PBDE, DBDE		
Weight	0.75 lbs (340 gm)		
Compliances	CE Mark EN61326-1, FCC Part15 Class A, FCC Part 68, RoHS		

12.1 Medical Alert

NOTICE

WRITTEN AUTHORIZATION BY THE PRESIDENT OF FLORITE INTERNATIONAL, INC. IS REQUIRED PRIOR TO USING ANY FLORITE PRODUCTS OR SERVICES AS CRITICAL COMPONENTS IN LIFE SUPPORT DEVICES OR SYSTEMS.

12.1.1 A critical component is any component of a life support device or system whose failure to perform can reasonably be expected to cause the failure of the life support device or system, or affect its safety or effectiveness.

12.1.2 Life support devices or systems are devices or systems which are as follows: Intended for surgical implant into the body; or Intended to support or sustain life; and in any case, whose failure to perform when properly used in accordance with the instructions provided in the labeling or operators manuals, can reasonably be expected to result in significant life threatening injury.

12.2 Federal Communications Commission Compliances

12.2.1 Part 15 Compliance

12.2.1.1 This equipment has been tested and found to comply with the limits for Class B digital device pursuant to part 15 of the FCC rules. These limits are designed to provide reasonable protection against harmful interference when the equipment is operated in residential, commercial and industrial environments. This equipment generates, uses, and can radiate frequency energy and, if not installed and used in accordance with the instruction manual, may cause harmful interference to radio communications.

12.2.1.2 Notice To User

This equipment complies with FCC Part governing limitations for radio frequency emissions. Operation is subject to two conditions as follows: (1) this device may not cause harmful interference, and (2) this device must accept any interference that may cause undesired operation.

12.2.1.3 Equipment Modification

Changes or modifications not expressly approved by the party responsible for compliance will void the user's authority to operate the equipment.

12.2.2 Part 68 Notice

12.2.2.1 A Federal Communication Commission (FCC) compliant telephone cord with modular plug is provided with your equipment to connect it to the public switched telephone line using a Universal Order Service Code (USOC) RJ-11 jack. Do not connect to party or coin lines. The sum of the REM numbers printed on the telephone line device for ALL devices connected to the telephone line, shall not exceed 5.0. This insures that each device connected to the line may respond properly when the line rings

12.2.2.2 You must provide the FCC Part 68 compliance registration information from the equipment label when requested by the telephone company.

Registrant: Florite International, Inc.
Number: 5TUUSA-23969-DT-E

12.2.2.3 The telephone company will notify you of network changes that may affect proper functioning of your equipment, and may temporarily discontinue service, or require the equipment to be disconnected from the line, if it is suspected of causing harm to the network. You will be informed by your telephone company of your rights to file complaints with the FCC.

12.3 EU Compliances

12.3.1 EMC Directive (CE Mark)

The European Union directive on electromagnetic compatibility (2004/108/EC) requires a non-European manufacturers to designate an authority representative in the Union-Community. Our European representative is

Compatible Electronics, Inc.
2337 Troutdale Dr.
Agoura, CA 91301

12.3.2 Waste Electrical and Electronic Equipment Directive (WEEE)

The European directive WEEE aims to minimize the impact of electrical and electronic equipment waste on the environment and human health. For proper treatment, recovery, and recycling, return the equipment to your local supplier upon the purchase of equivalent new equipment, or dispose of it in designated collection points. For further information - visit www.recyclethis.com.

12.4 Hazardous Waste

12.5.1 Florite instruments may incorporate real-time clock operation which is supported by a 3.0 volt, 35 milliamp-hour lithium battery during periods during which the instruments power is disconnected. the battery is not a user serviceable component, and is guaranteed for a period of nine (9) years from the date the original purchaser purchased the instrument.

12.5.2 Contact Florite International, Inc. to return the instrument for battery replacement service should it be observed that the clock time is affected following instrument power loss. The battery is exclusively a factory replacement component, and in no case shall the original product purchaser attempt to remove or replace the battery, which requires the instrument to be opened, which will immediately void the terms and conditions of the instruments Limited Warranty. Prior to sending the instrument to Florite for service, contact www.florite.com, Service Department, who will issue a return-materials-authorization number. The instrument must return a copy of the original purchase invoice to receive service.

12.5.3 In no circumstance will Florite be responsible for customer expenses associated with the need for battery replacement, such as, but not limited to, unit de-installation, re-installation, or in all cases, irrespective of the instruments Warranty status.

12.5.4. Returned instrument for battery replacement shall be shipped by the customer return freight prepaid. Instruments beyond the original Warranty period are subject to a battery service charge in the 50% of the prevailing clock option list price.

12.5 Legal Notices

12.6.1 Trademarks and Patents

Florite and the Florite Logo symbol are trademarks of Florite International, Inc. Other trade names which may be used in this document may be trademarks or registered trademarks of the manufacturers or vendors of the respective products.

12.6.2 Disclaimer

12.6.2.1 The information in this document is subject to change without notice at any time. Florite International, Inc. assumes no responsibility for inaccuracies or omissions, and specifically disclaims any liabilities, losses, or risks, personal or otherwise, incurred as a consequence, directly or indirectly, of the use or application of any of the contents of this document. For the latest documentation, contact your local supplier or visit us online at www.florite.com.

12.6.2.2 This publication may contain examples of screen captures and reports used in daily operation. Any such examples may include fictitious names of individuals and companies. Any similarity to names and addresses of actual businesses or persons is entirely coincidental.

12.3.2.2 This equipment contains no user serviceable internal constituents. Opening the equipment case voids the original product Limited Warranty terms and conditions.

12.6.3 Intended Equipment Use

This product shall be used only for the purpose it was designed and manufactured; refer to the product Data Sheet and user documentation. For the latest product information, contact your local supplier, or visit us online at www.florite.com.

12.6.4 This Document Copyright © 2014 Florite International, Inc.

All rights are reserved. This document may not be copied in whole, or in part or otherwise reproduced without prior written consent received from Florite International, Inc., except where specifically permitted under US and international copyright law. Document Number-Revision: D10173-061714