

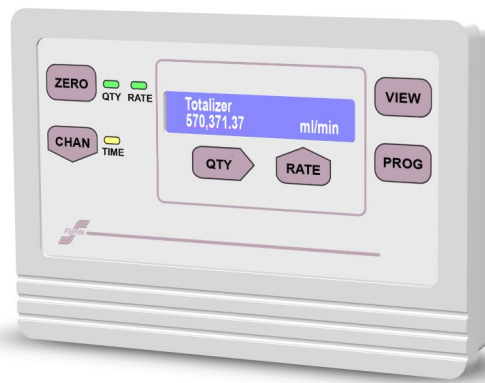

## Instrument Training Guide

---

### 900 Series



## Installation Instruction

- 1 Connect input or output into instrument port as shown
- 2 Insert power plug into PWR jack as shown
- 3 Plug the D9 part of the RS-232 connector into a computer serial port. Insert the plug on the other end of the cable into the PGM jack as shown.
- 4 When your unit is installed with the WAN modem option then plug either end of an RJ-11 cable into the corresponding jack and the other end of the cable into a standard telephone jack as shown.
- 5 When the relay output option is installed then plug the output cable into the REM jack and connect the wires shown to the controlled equipment.
- 6 When the analog output option is installed then plug the cable into the REM jack and connect the wires shown to the controlled equipment.

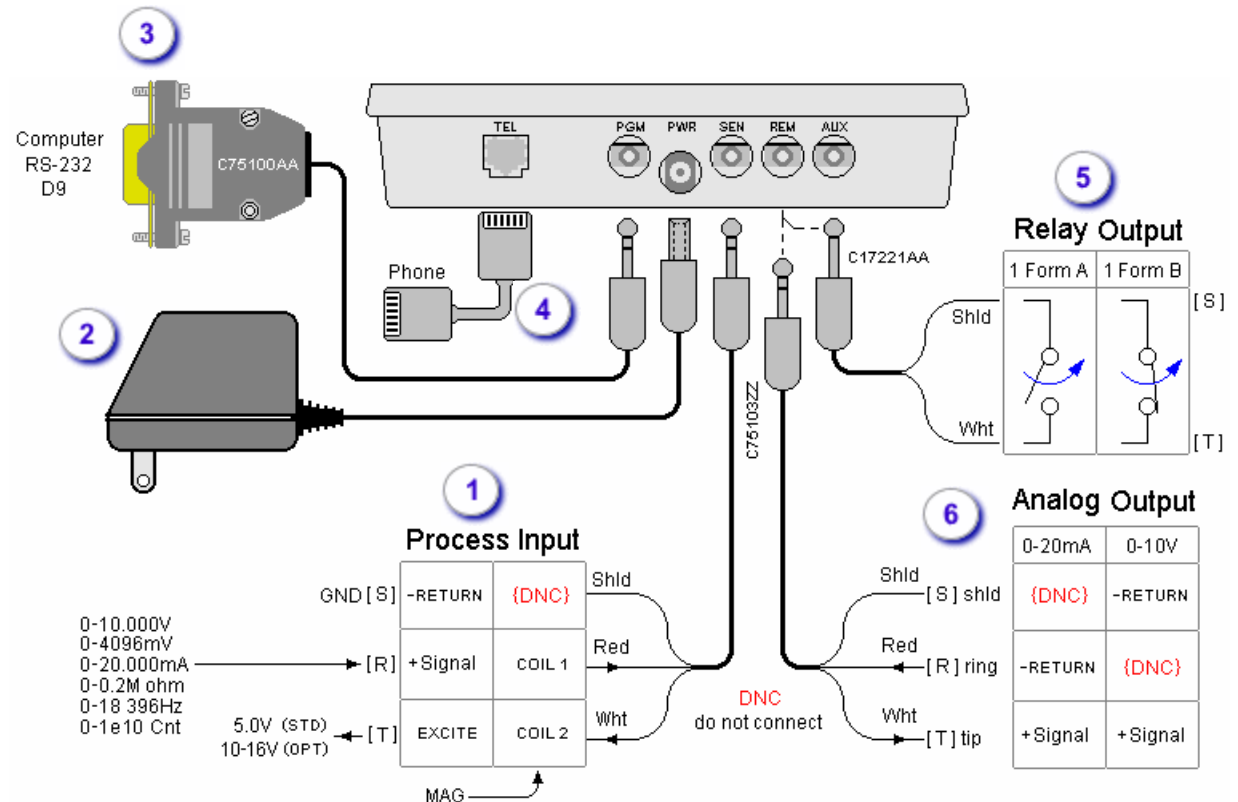
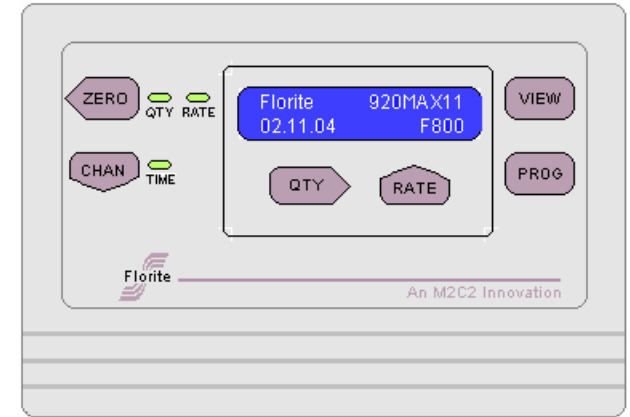

## Quick Programming Instructions

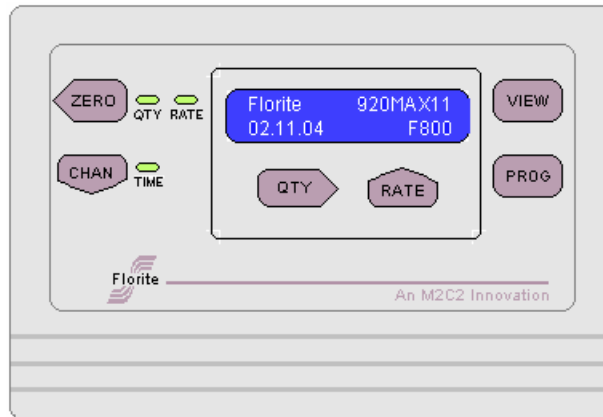

Press the CHAN button until reaching Input Port 1 (note: a 1 will be located in the upper right hand corner of the display).

### **Pulse Output Sensors**

Press the PROG button until reaching the Pulse Constant screen followed by setting the number to correspond to the sensors number of pulses per quantity. After setting the sensors Meter Constant again press the PROG button to save the value.

### **Analog Output Sensors**

Press the PROG button until reaching the Low Value screen followed by setting the numbers for the lowest analog input level. Then press the PROG button until reaching the Low Units screen and set the numbers for the lowest measurement units that the Low Value represents.

Press the PROG button until reaching the High Value screen, followed by setting the numbers for the highest analog input level. Then press the PROG button until reaching the High Units screen and set the numbers for the highest measurement units that the High Value represents.

Press the VIEW key to return to the main screen.

To program the units of measure press the PROG button until reaching the Measure Units screen.

## 900 Series Instrument

- Keypad & Functions
- Lamp Indicators
- Navigation & Structure
- Programming Navigation
- Viewing Navigation
- Optional Configuration

# Instrument Keypad & Functions

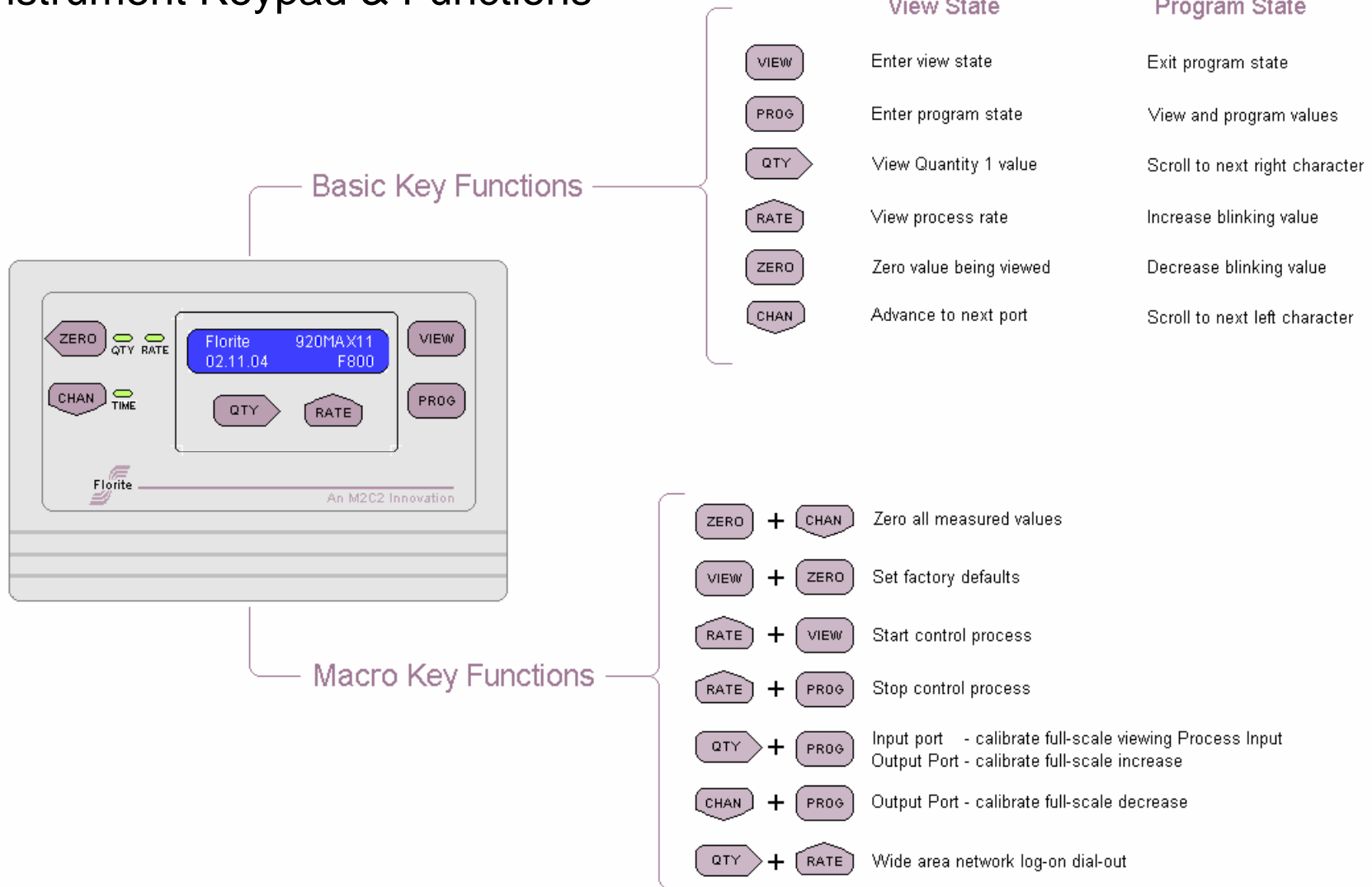

Florite International, Inc. warrants that every reasonable effort has been made to assure the accuracy of the information contained herein, however, assumes no responsibility for its use. The information is subject to change at any time without notice, and no part of it may be reproduced without prior agreement and written consent of Florite International, Inc.

All rights reserved © 2007

# Lamp Indicators

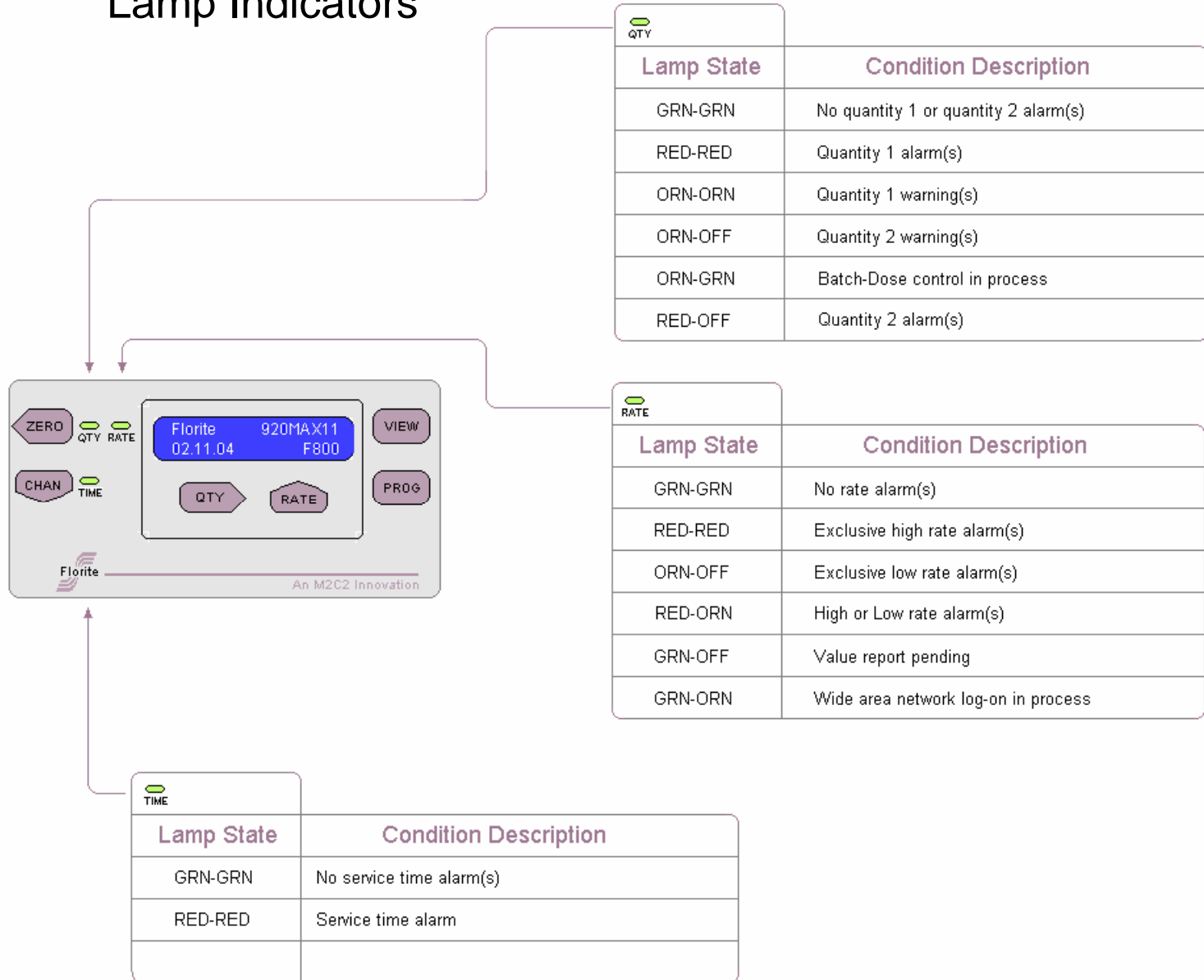

NOTE: LAMP STATES SHOWN AS ALTERNATING COLORS WHERE ORN-OFF MEANS CHANGING BETWEEN ORANGE THEN NOT ILLUMINATED

## 900 Series

### Instrument Navigation & Structure

## 900 Series Navigate Input-Output Control

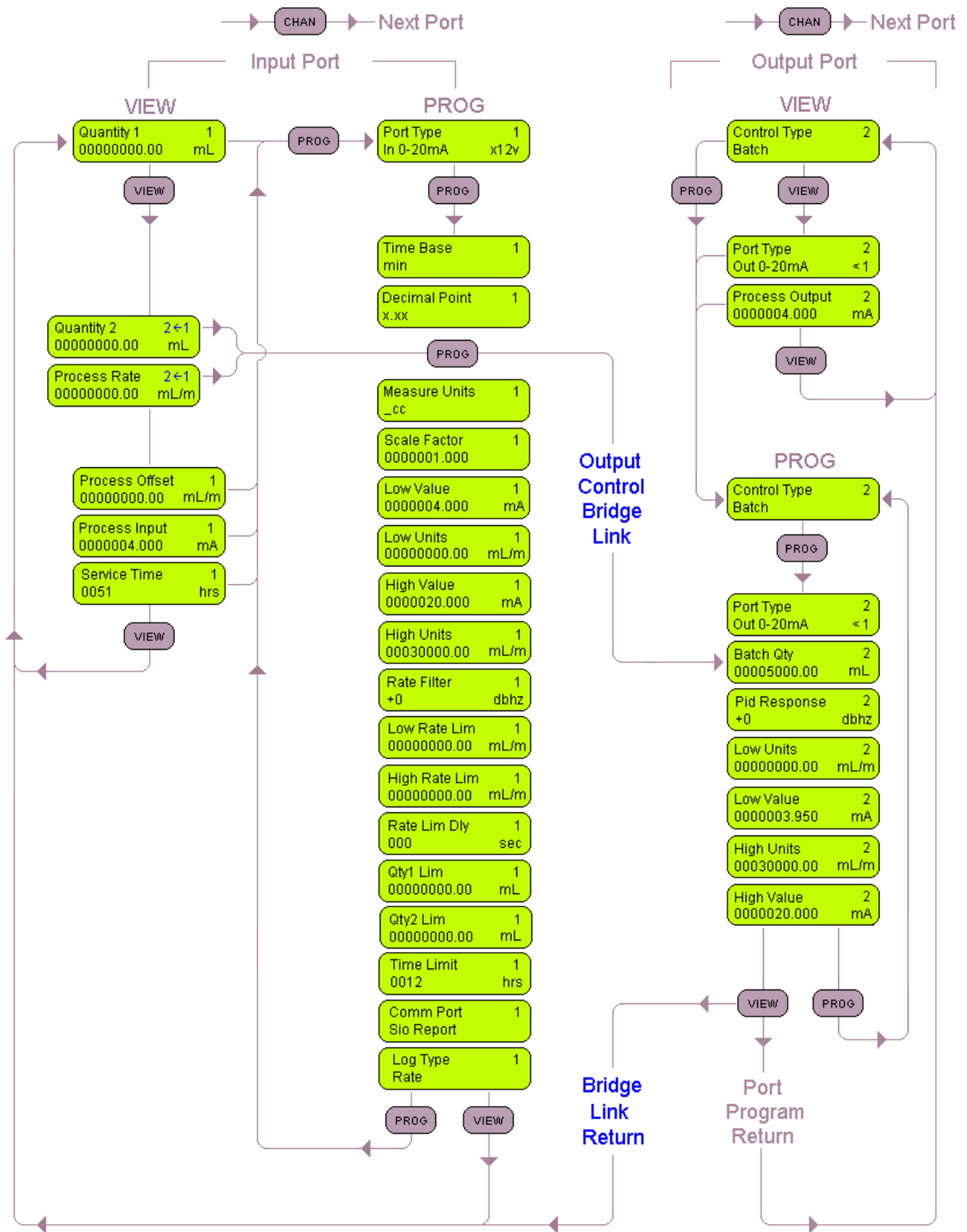



900 Series

Instrument Programming Navigation

## M920 Configuration

Prog Value	Port 1	Port 2
Port Type		
Input Excitation		
Input Link		
Time Base		
Measure Units		
In Low Value		
In Low Units		
In High Value		
In High Units		
Pulse Constant		
Rate Filter		
Low Rate Lim		
High Rate Lim		
Rate Alarm Dly		
Quantity 1 Lim		
Quantity 2 Lim		
Time Limit		
Comm Port		
Decimal Point		
Log Select		
Ctrl Type		
Ctrl Amount		
Pid Response		
Out Low Units		
Out Low Value		
Out Hi Units		
Out Hi Value		

System				
Prog Value		Prog Option		
Network Addr	00000	Log	ON	OFF
Log Freq	000 / min	Err	ON	OFF
Date-Time	01Nov05	Cmp	ON	OFF
Report Start	01Jan06	Sec	ON	OFF
Report Freq	000 / min	Lok	ON	OFF
Alarm Phone	0000000000000000	Bat	ON	OFF
Report Phone	0000000000000000	Sup	ON	OFF
Answer Rings	000	Bep	ON	OFF

# 900 Series Navigate System Parameters

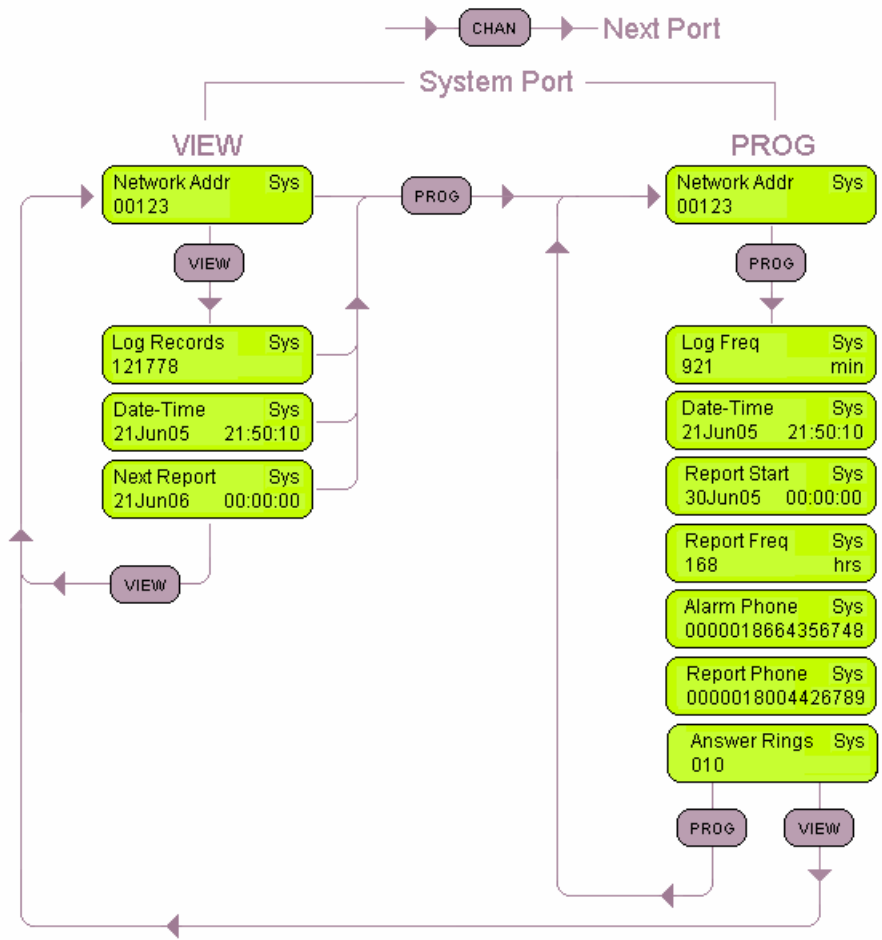

## Network Address - System Program

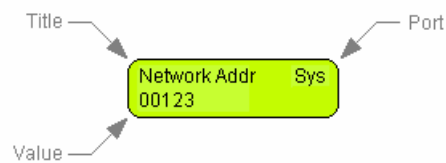

### **Function**

This screen is used to program the base address for serial communication programming and information reporting.

### **Navigation**

Access this screen by pressing the CHAN key until reaching the "Sys" port - and then pressing the PROG key until reaching the desired screen. Note the first character field blinks indicating readiness for programming.

### **Select**

- Field - by pressing either the QTY (right) or CHAN (left) key.
- Character - change by pressing either the ZERO (down) or RATE (up) key.
- Program - save new value by pressing the PROG key.

## Report Start - System Program



### **Function**

This screen is used to program the date and time that scheduled value reports for each input port having Comm Port appropriately set are to then be sent. It is comprised of a date field and a 24 hour clock time field.

### **Navigation**

Access this screen by pressing the CHAN key until reaching the "Sys" port - and then pressing the PROG key until reaching the desired screen. Note the first character field blinks indicating readiness for programming.

### **Select**

- Field - by pressing either the QTY (right) key.
- Character - change by pressing RATE (up) key.
- Program - save new value by pressing the PROG key.

## Reporting Frequency - System Program

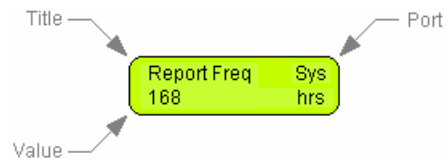

### **Function**

This screen is used to program the rate at which measurement information is send for each input port having its Comm Port set. It is comprised of a three character numeric field and a time field.

### **Navigation**

Access this screen by pressing the CHAN key until reaching the "Sys" port - and then pressing the PROG key until reaching the desired screen. Note the first character field blinks indicating readiness for programming.

### **Select**

- Field - by pressing either the QTY (right) or CHAN (left) key.
- Character - change by pressing either the ZERO (down) or RATE (up) key.
- Program - save new value by pressing the PROG key.

## Alarm and Report Phone Numbers - System Program

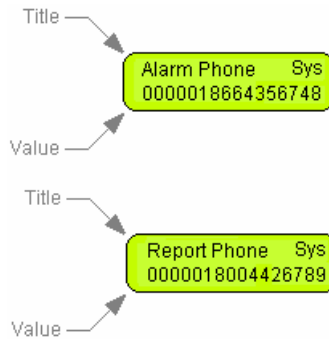

### **Function**

These screens are used to program the phone numbers to remotely access computers and data collection equipment to report either one or more alarm conditions, or to send scheduled measurement information from input ports having their Comm Port appropriately set.

Should an alarm condition occur without the alarm number programmed - the alarm will be sent to the report phone number to insure alarm information is reported. When scheduled reports are enabled - alarm information will be sent along with the value report which will be delayed by the programmed Report Frequency.

### **Navigation**

Access these screens by pressing the CHAN key until reaching the "Sys" port - and then pressing the PROG key until reaching the desired screen. Note the first character field blinks indicating readiness for programming.

### **Select**

- Field - by pressing either the QTY (right) or CHAN (left) key.
- Character - change by pressing either the ZERO (down) or RATE (up) key.
- Program - save new value by pressing the PROG key.

## Answer Rings - System Program

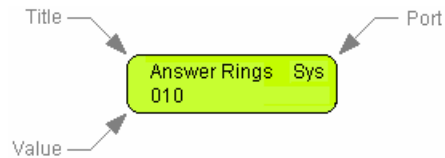

### **Function**

This screen is used to program the number of public switched telephone system rings after which the ringing line is answered by the instrument. The line will not be answered if set to zero. This function is often used for maintenance, diagnostic, and general remote access purposes.

### **Navigation**

Access this screen by pressing the CHAN key until reaching the "Sys" port - and then pressing the PROG key until reaching the desired screen. Note the first character field blinks indicating readiness for programming.

### **Select**

- Field - by pressing either the QTY (right) or CHAN (left) key.
- Character - change by pressing either the ZERO (down) or RATE (up) key.
- Program - save new value by pressing the PROG key.



## Log Records - System View



### **Function**

This screen is used to view the number of data records that have been logged. This screen is also used to completely control the logging functions including start, stop, upload and zero records.

### **Navigation**

Access this screen by pressing the CHAN key until reaching the "Sys" port - and then pressing the VIEW key until reaching the desired screen. Note the first character field blinks indicating readiness for programming.

## Network Address - System View

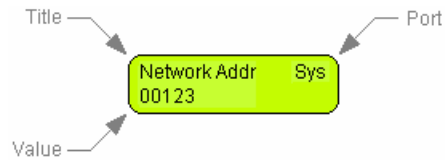

### **Function**

This screen is used to view the instruments programmed communication base address.

### **Navigation**

Access this screen by pressing the CHAN key until reaching the "Sys" port - and then pressing the VIEW key until reaching the desired screen. Note the first character field blinks indicating readiness for programming.

## Date-Time - System View

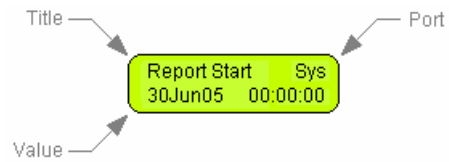

### **Function**

This screen is used to view the real time clocks date and time having a 24 hour clock time field.

### **Navigation**

Access this screen by pressing the CHAN key until reaching the "Sys" port - and then pressing the VIEW key until reaching the desired screen. Note the first character field blinks indicating readiness for programming.

## Next Report Date-Time - System View

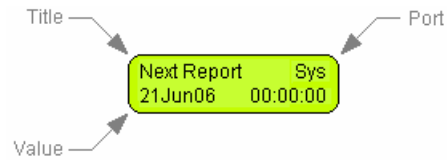

### **Function**

This screen is used to view the date and time that a next regularity scheduled value report is to be sent.

### **Navigation**

Access this screen by pressing the CHAN key until reaching the "Sys" port - and then pressing the VIEW key until reaching the desired screen. Note the first character field blinks indicating readiness for programming.

## Log Frequency - System Program

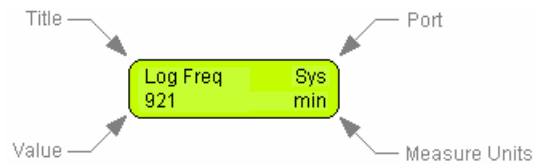

### **Function**

This screen is used to program the rate at which measurement information is placed as records into the logging memory. It is comprised of a three character numeric field and a time field.

### **Navigation**

Access this screen by pressing the CHAN key until reaching the "Sys" port - and then pressing the PROG key until reaching the desired screen. Note the first character field blinks indicating readiness for programming.

### **Select**

- Field - by pressing either the QTY (right) or CHAN (left) key.
- Character - change by pressing either the ZERO (down) or RATE (up) key.
- Program - save new value by pressing the PROG key.

# 900 Series Navigate Input Port

→ CHAN → Next Port

Input Port

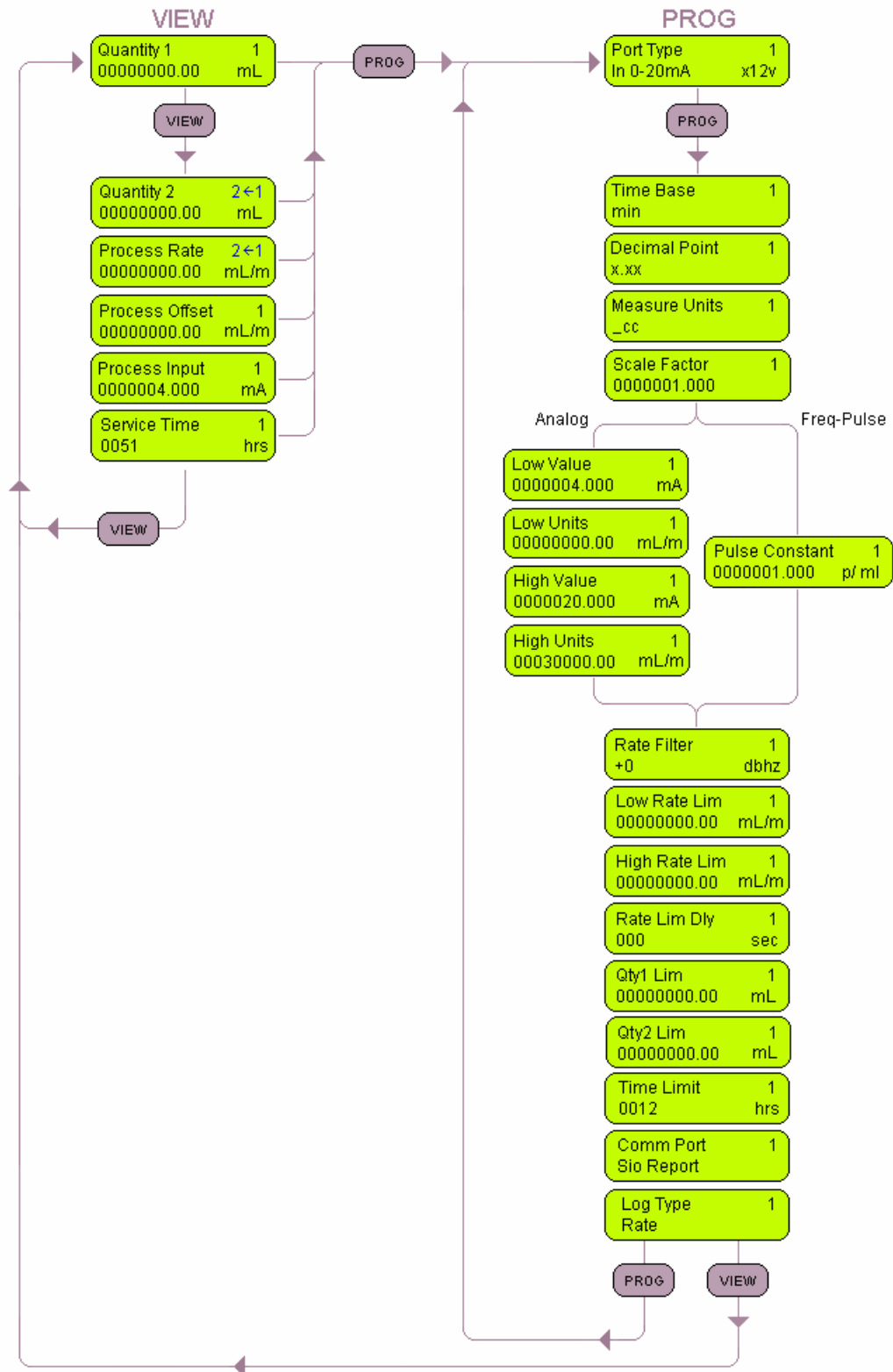

## Port Type - Input Program



### **Function**

This screen is used to program an input (or output) port for the installed port module. The input Port Type may be programmed to service the selected input signal Type and Execution.

### **Navigation**

Access this screen by using the CHAN key until reaching the desired port number, and then by using the PROG key until reaching this screen. Note the display Type field portion blinks indicating readiness for programming.

### **Select**

- Field - independently select the input signal field or excitation field using the QTY (right) or CHAN (left) keys.
- Type Field - select an input signal type by pressing either the ZERO (down) or RATE (up) key to select one of the following:
  - Freq (0-24,570Hz)
  - Volt (0-4000mV)
  - Volt (0-10V)
  - Current (0-20mA)
  - Ohms
- Excitation Field - select Excitation by pressing either the ZERO (down) or RATE (up) key to select from the following:
  - +5.0 volts
  - +12 volts
  - Vn volts
- Program - save new Type and Excitation selections by pressing the PROG key.

## Time Base - Input Program

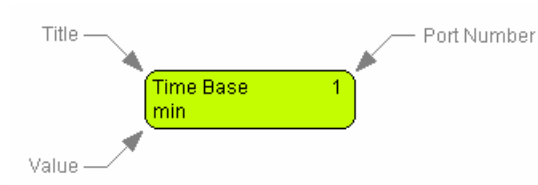

### **Function**

This screen is used to program the time base used for input signal rate and quantity measurements.

### **Navigation**

Access this screen by using the CHAN key until reaching the desired port number, and then by using the PROG key until reaching this screen. Note the value field blinks indicating readiness for programming.

### **Select**

- Press either ZERO (down) or RATE (up) to select the desired time base.
- Press PROG key to save the new selection.



## Decimal Point - Input Program

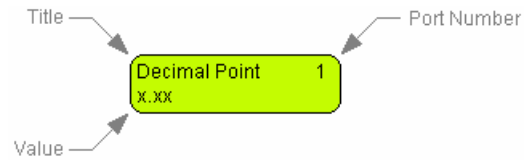

### **Function**

This screen is used to program the number of measurement value digits to the right of the decimal point.

### **Navigation**

Access this screen by using the CHAN key until reaching the desired port number, and then by using the PROG key until reaching this screen. Note the value field blinks indicating readiness for programming.

### **Select**

Press either ZERO (down) or RATE (up) to select the desired decimal places and press the PROG key to save the new selection.

## Measure Units - Input Program

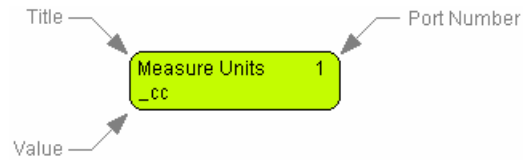

### **Function**

This screen is used to program a three character field defining units of measure representing the physical engineering measurement.

### **Navigation**

Access this screen by using the CHAN key until reaching the desired port number, and then by using the PROG key until reaching this screen. Note the first character field blinks indicating readiness for programming.

### **Select**

- Field - by pressing either the QTY (right) or CHAN (left) key.
- Character - change by pressing either the ZERO (down) or RATE (up) key.
- Program - save new units character string by pressing the PROG key.

## Scale Factor - Input Program

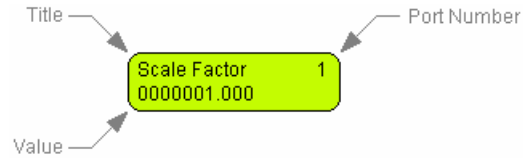

### **Function**

This screen is used to program a factor by which a measured input rate is multiplied to change its magnitude.

### **Navigation**

Access this screen by using the CHAN key until reaching the desired port number, and then by using the PROG key until reaching this screen. Note the first character field blinks indicating readiness for programming.

### **Select**

- Field - by pressing either the QTY (right) or CHAN (left) key.
- Value - change by pressing either the ZERO (down) or RATE (up) key.
- Program - save new units character string by pressing the PROG key.

## Pulse Constant - Input Program

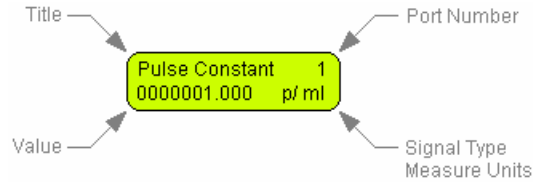

### **Function**

This screen is used to program the factor by which measured pulse inputs are converted to an engineering value in the measure units indicated. This screen only available with "In Freq" input Port Type selected.

### **Navigation**

Access this screen by using the CHAN key until reaching the desired port number, and then by using the PROG key until reaching this screen. Note the first character field blinks indicating readiness for programming.

### **Select**

- Field - by pressing either the QTY (right) or CHAN (left) key.
- Value - change by pressing either the ZERO (down) or RATE (up) key.
- Program - save new units character string by pressing the PROG key.

## Input Interpolation - Input Program

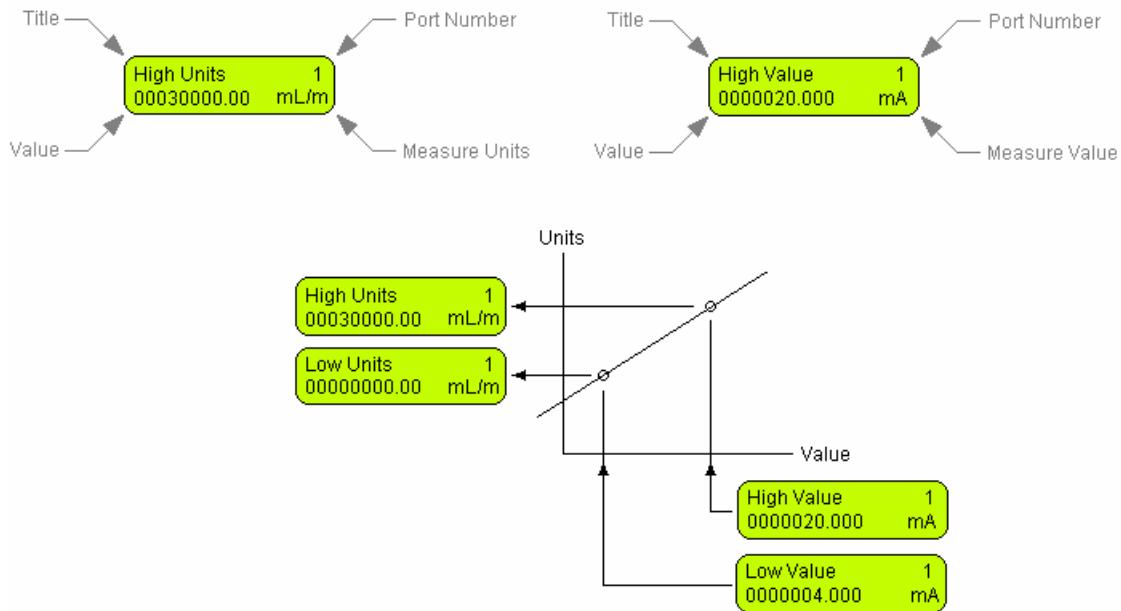

### Function

The purpose of these screens in combination provides for linear interpolation of measured analog input values to be represented as a physical measurement meaning in engineering units.

### Navigation

Access these screens by using the CHAN key until reaching the desired port number, and then by using the PROG key until reaching this screen. Note the first numeric field blinks indicating readiness for programming.

### Select

- Field - select value to change by pressing either the QTY (right) or CHAN (left).
- Value - change selection by pressing either the ZERO (down) or RATE (up) key.
- Program - save new selection by pressing the PROG key.

## Rate Filter - Input Program

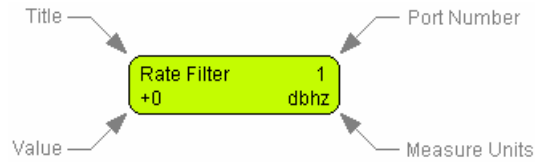

### **Function**

This screen is used to program the factor which determines the amount of filtering to be applied to the rate measurement. The filtering range is from +0 to -20 dbHz representing the magnitude of noise and jitter suppression. Filtering is usually applied to average pulsations and reject transients in the process being measured. Larger negative values represent increased filtering.

### **Navigation**

Access this screen by using the CHAN key until reaching the desired port number, and then by using the PROG key until reaching this screen. Note the character field blinks indicating readiness for programming.

### **Select**

- Value - change by pressing either the ZERO (down) or RATE (up) key.
- Program - save new value by pressing the PROG key.

## Low Rate Limit

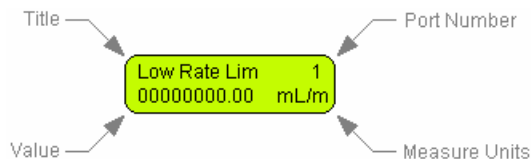

### **Function**

This screen is used to program the rate value below which an alarm is detected.

### **Navigation**

Access this screen by using the CHAN key until reaching the desired port number, and then by using the PROG key until reaching this screen. Note the first numeric field blinks indicating readiness for programming.

### **Select**

- Field - select value to change by pressing either the QTY (right) or CHAN (left).
- Value - change value by pressing either the ZERO (down) or RATE (up) key.
- Program - save new selection by pressing the PROG key.

## Hi Rate Limit - Input Program

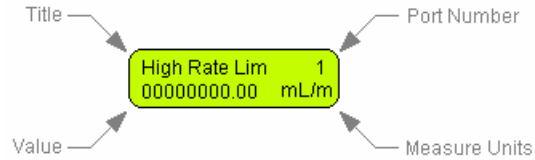

### **Function**

This screen is used to program the rate value above which an alarm is detected.

### **Navigation**

Access this screen by using the CHAN key until reaching the desired port number, and then by using the PROG key until reaching this screen. Note the first numeric field blinks indicating readiness for programming.

### **Select**

- Field - select value to change by pressing either the QTY (right) or CHAN (left).
- Value - change value by pressing either the ZERO (down) or RATE (up) key.
- Program - save new selection by pressing the PROG key.



## Rate Limit Delay - Input Program

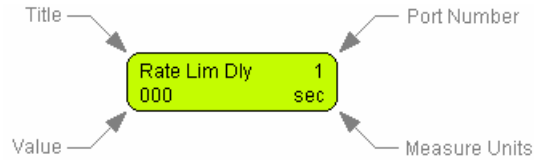

### **Function**

This screen is used to program the time period over which a rate alarm must have been detected and continuously persisted prior to the alarm condition is declared to be a qualified alarm.

### **Navigation**

Access this screen by using the CHAN key until reaching the desired port number, and then by using the PROG key until reaching this screen. Note the first numeric field blinks indicating readiness for programming.

### **Select**

- Field - select value to change by pressing either the QTY (right) or CHAN (left).
- Value - change value by pressing either the ZERO (down) or RATE (up) key.
- Program - save new selection by pressing the PROG key.

## Qty 1 Lim - Input Program

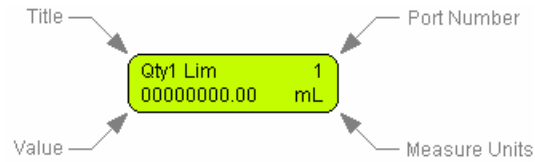

### **Function**

This screen is used to program the quantity amount above which a quantity 1 alarm condition is declared.

### **Navigation**

Access this screen by using the CHAN key until reaching the desired port number, and then by using the PROG key until reaching this screen. Note the first numeric field blinks indicating readiness for programming.

### **Select**

- Field - select value to change by pressing either the QTY (right) or CHAN (left).
- Value - change value by pressing either the ZERO (down) or RATE (up) key.
- Program - save new selection by pressing the PROG key.

## Qty 2 Lim - Input Program

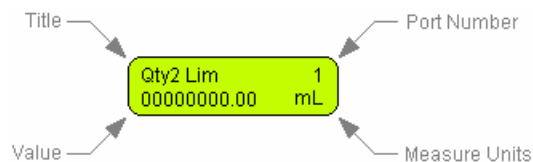

### **Function**

This screen is used to program the quantity amount above which a quantity 2 alarm condition is declared.

### **Navigation**

Access this screen by using the CHAN key until reaching the desired port number, and then by using the PROG key until reaching this screen. Note the first numeric field blinks indicating readiness for programming.

### **Select**

- Field - select value to change by pressing either the QTY (right) or CHAN (left).
- Value - change value by pressing either the ZERO (down) or RATE (up) key.
- Program - save new selection by pressing the PROG key.

## Time Limit - Input Program

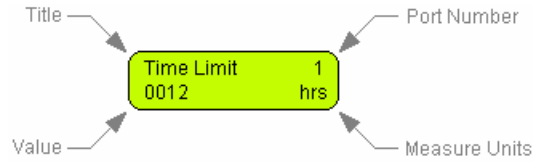

### **Function**

This screen is used to program the service time amount above which a service time alarm condition is declared.

### **Navigation**

Access this screen by using the CHAN key until reaching the desired port number, and then by using the PROG key until reaching this screen. Note the first numeric field blinks indicating readiness for programming.

### **Select**

- Field - select value to change by pressing either the QTY (right) or CHAN (left).
- Value - change value by pressing either the ZERO (down) or RATE (up) key.
- Program - save new selection by pressing the PROG key.

## Communication Port - Input Program

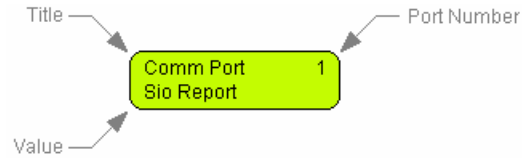

### **Function**

This screen is used to program which of the available communication ports from which to send report information when the reporting capability is enabled.

### **Navigation**

Access this screen by using the CHAN key until reaching the desired port number, and then by using the PROG key until reaching this screen. Note the character field blinks indicating readiness for programming.

### **Select**

- Value - change by pressing either the ZERO (down) or RATE (up) key.
- Program - save new selection by pressing the PROG key.

## Log Type

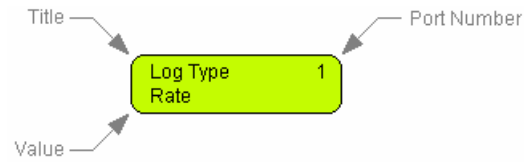

### **Function**

This screen is used to program the measured rate or accumulated quantity for an input port what is to be placed in a date-time stamped log record.

### **Navigation**

Access this screen by using the CHAN key until reaching the desired port number, and then by using the PROG key until reaching this screen. Note the first numeric field blinks indicating readiness for programming.

### **Select**

- Value - change selection by pressing either the ZERO (down) or RATE (up) key.
- Program - save new selection by pressing the PROG key.

900 Series

Instrument Viewing Navigation

## Quantity 1 - Input View

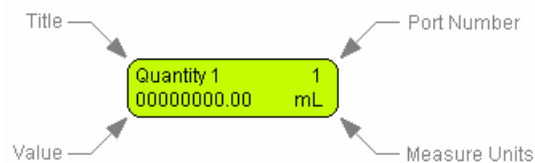

### **Function**

This screen is used to independently view and zero the accumulated port quantity 1 when the port time base is set for seconds, minutes, hours or days.

### **Navigation**

Access this screen by using the CHAN key until reaching the desired port number, and then by using the VIEW key until reaching this screen.

### **Zero Value**

Press the ZERO key while viewing.



## Quantity 2 - Input View

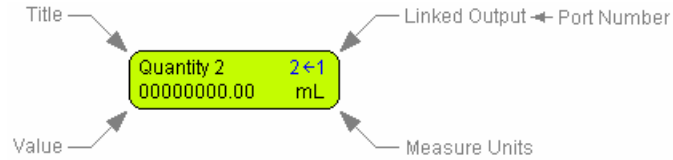

### **Function**

This screen is used to independently view and zero the accumulated port quantity 2 when the port time base is set for seconds, minutes, hours or days.

The output port link number and arrow are displayed blinking when the linked output is performing a control function that requires using quantity 2 to perform the control process.

### **Navigation**

Access this screen by using the CHAN key until reaching the desired port number, and then by using the VIEW key until reaching this screen.

### **Zero Value**

Press the ZERO key while viewing.

## **Rate/Value - Input View**

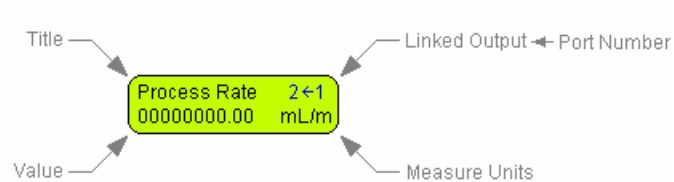

### **Function**

This screen is used to view the present process rate when the port time base is set for seconds, minutes, hours or days, or scalar value when the time base is set for scalar.

The output port link number and arrow are displayed blinking when the linked output is performing a control function that requires using the measured rate to perform the control process.

### **Navigation**

Access this screen by using the CHAN key until reaching the desired port number, and then by using the VIEW key until reaching this screen.

### **Rate Offset - Tare**

Press the ZERO key while viewing this screen to cause the present measured rate to be saved as the Process Offset. This causes all succeeding rate measurements to be offset by the amount that was being displayed prior to pressing the ZERO key. Capturing an offset directly affects accumulated quantities.

## Process Offset - Input View

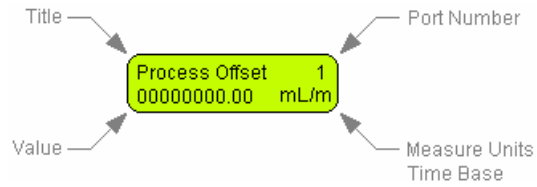

### **Function**

This screen is used to view the present process rate-value offset or tare value.

### **Navigation**

Access this screen by using the CHAN key until reaching the desired port number, and then by using the VIEW key until reaching this screen.

### **Zero Process Offset**

Press the ZERO key while viewing this screen to cause the present offset value to be zero.

## Process Input - Input View

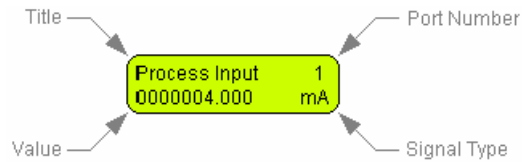

### **Function**

This screen is used to view input signal measurement values for install diagnostic purposes, and is also used to perform zero and full-scale calibrations for the port.

### **Navigation**

Access this screen by using the CHAN key until reaching the desired port number, and then by using the VIEW key until reaching this screen.

### **Diagnostic**

The screen value indicates the value presently being input into the port.

### **Calibrations**

- Analog Zero
  - Select the Port Type as either mA or volts. Insure that no signal is connected to the port input jack. Press the ZERO key. Note the value now indicates zero.
- Current Full Scale
  - Select the Port Type as mA. Input 20.000 mA into the port. Simultaneously press the ZERO and VIEW keys. Note that the value now indicates 20.000 mA.
- Volts Full Scale
  - Select the Port Type as Volt. Input 10.000 volts into the port. Simultaneously press the ZERO and VIEW keys. Note that the value now indicates 20.000 mA.
- Ohms Calibrate
  - Select the Port Type as Ohm. Install a known resistor value into the port. Program the known value into the Cal Factor screen. Simultaneously press the ZERO and VIEW keys. Note that the value now indicates the known resistance value.

## Service Time - Input View

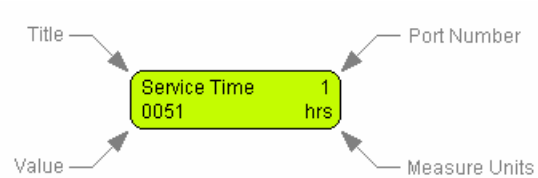

### **Function**

This screen is used to view the present accumulated input port service time. This value is often used for such purposes as maintenance scheduling as a Hobbs Hour-Meter would be used.

### **Navigation**

Access this screen by using the CHAN key until reaching the desired port number, and then by using the VIEW key until reaching this screen.

### **Zero Service Time**

Press the ZERO key while viewing this screen to cause the accumulated hours to be zero.

# 900 Series Navigate Output Port

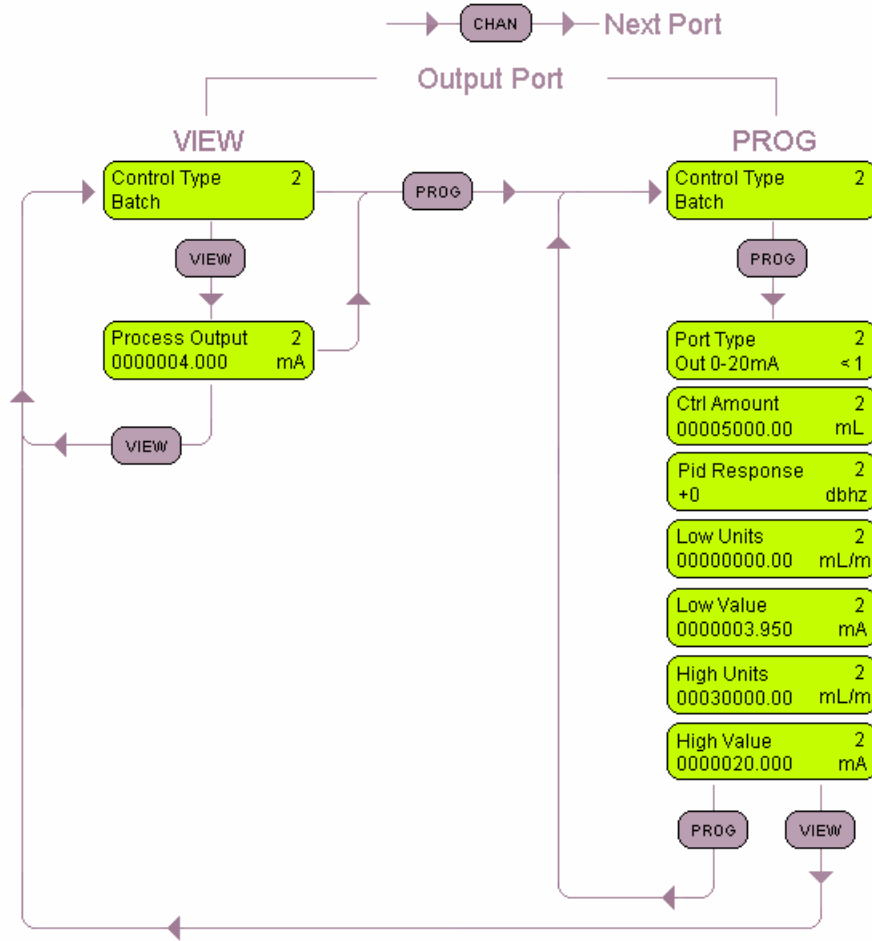

## Port Type - Output Program

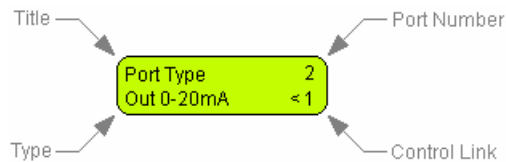

### **Function**

This screen is used to program an output (or input) port for the installed port module. The output Port Type may be programmed to service the selected output signal Type and Link.

### **Navigation**

Access this screen by using the CHAN key until reaching the desired port number, and then by using the PROG key until reaching this screen. Note the display Type field portion blinks indicating readiness for programming.

### **Select**

- Field - independently select the signal type field or link field using the QTY (right) or CHAN (left) keys.
- Type Field - select the output signal type by pressing either the ZERO (down) or RATE (up) key to select one of the following:
  - Volt (0-10V)
  - Current (0-20mA)
  - Relay
- Link Field - select the link port number pressing either the ZERO (down) or RATE (up) key. The link port number is the input port from which the output port acquires measurement values used by the output port to perform its selected Control Type function.

Program - save new Type and Link selections by pressing the PROG key.

## Control Type - Output Program

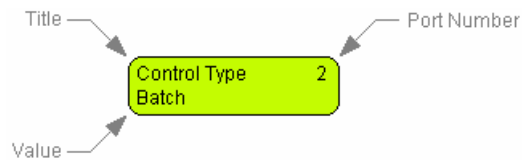

### **Function**

This screen is used to program a desired output control function. A linked input port programmed in the outputs Port Type provides process measurement information required for the output port to perform its selected function.

### **Navigation**

Access this screen by using the CHAN key until reaching the desired output port number, and then by using the PROG key until reaching this screen. . Note the character field blinks indicating readiness for programming.

### **Select**

Field - select the Control Type using the QTY (right) or CHAN (left) key select one of the following:

- Monitor
  - Analog output Port Type - converts and outputs its linked input port measurement as an analog signal which has been scaled using the output port interpolation values.
  - Relay output Port Type - energizes the output relay when the linked input port detects an alarm condition.
- Manual - linked input measurements are ignored. The value set in the Control Amount is converted to an analog value using the output port interpolation values, resulting in a corresponding analog signal appearing at the output port terminals.
- Batch - causes the quantity set in the Control Amount to be delivered when a batch process is started.
- Dose - causes injector activation when the quantity set in the Control Amount reached.
- PID - causes linked input rate or value measurement to be continuously maintained to be the value set in the Control Amount.

Program - save new Control Type selection by pressing the PROG key.



## Control Amount - Output Program

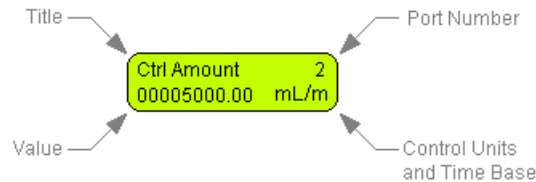

### **Function**

This screen is used to program a desired output value or rate used by the output port to accomplish the requirements of its selected Control Type.

The Control Amount units and time base are the same as the input port, which had been programmed as the input link in this outputs Port Type. The linked input port provides process measurement information as may be required for the output port to perform its selected function.

### **Navigation**

Access this screen by using the CHAN key until reaching the desired output port number, and then by using the PROG key until reaching this screen. Note the first numeric field blinks indicating readiness for programming.

### **Select**

- Field - select value to change by pressing either the QTY (right) or CHAN (left).
- Value - change selection by pressing either the ZERO (down) or RATE (up) key.
- Program - save new selection by pressing the PROG key.

### **Control Type Functions**

- Monitor - Control Amount unused.
- Manual - Control Amount is converted to an analog value using the output port interpolation values to produce the desired analog output magnitude. Linked input measurements are ignored.
- Batch - Control Amount is a quantity to be delivered by an output port.
- Dose - Control Amount is a quantity when reached which causes injector actuation.
- PID - Control Amount is the rate or value for the linked input measurement which is desired to be continuously maintained.

## PID Response - Output Program

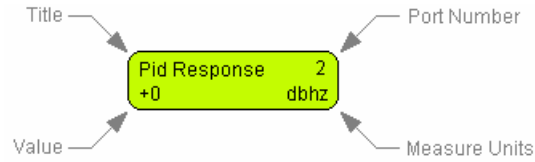

### **Function**

This screen is used to program the factor which determines the bandwidth - time response - applied to the PID output. The response range is from +0 to -20 dbHz which represents the response magnitude. Larger negative values represent a lower bandwidth (slower) response. This value is used to match the controlled plant bandwidth to the control bandwidth.

### **Navigation**

Access this screen by using the CHAN key until reaching the desired port number, and then by using the PROG key until reaching this screen. Note the character field blinks indicating readiness for programming.

### **Select**

- Field - this value has a single field.
- Value - change by pressing either the ZERO (down) or RATE (up) key.
- Program - save new value by pressing the PROG key.

## Output Interpolation - Output Program

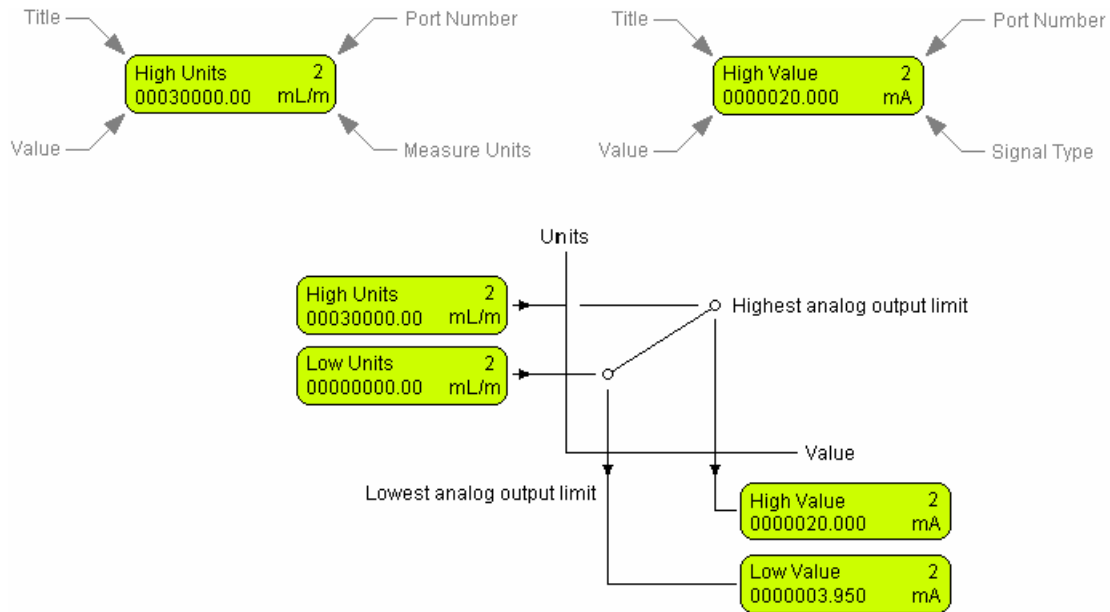

### **Function**

The purpose of these screens in combination provides for linear interpolation of a physical measurement in engineering units to be represented by an analog output signal type. The programmed High/Low Values additionally serve respectively as the highest or lowest analog output values that are allowed to be output.

### **Navigation**

Access these screens by using the CHAN key until reaching the desired output port number, and then by using the PROG key until reaching this screen. Note the first numeric field blinks indicating readiness for programming.

### **Select**

- Field - select value to change by pressing either the QTY (right) or CHAN (left).
- Value - change selection by pressing either the ZERO (down) or RATE (up) key.
- Program - save new selection by pressing the PROG key.

## Control Type - Output View

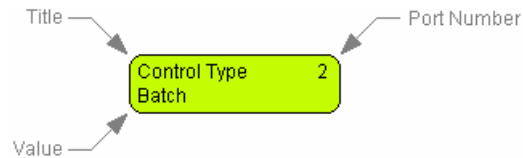

### **Function**

This screen is used to view the present Control Type.

### **Navigation**

Access this screen by using the CHAN key until reaching the desired output port number, and then by using the VIEW key until reaching this screen.

### **Control Types**

- Monitor
  - Analog output Port Type - converts and outputs its linked input port measurement as an analog signal which has been scaled using the output port interpolation values.
  - Relay output Port Type - energizes the output relay when the linked input port detects an alarm condition.
- Manual - linked input measurements are ignored. The value set in the Control Amount is converted to an analog value using the output port interpolation values, resulting in a corresponding analog signal appearing at the output port terminals.
- Batch - causes the quantity set in the Control Amount to be delivered when a batch process is started.
- Dose - causes injector activation when the quantity set in the Control Amount reached.
- PID - causes linked input rate or value measurement to be continuously maintained to be the value set in the Control Amount.

## Process Output - Output View

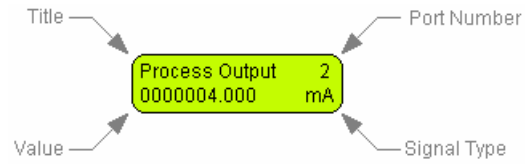

### **Function**

This screen is used to view the output signal value for install diagnostic purposes.

### **Navigation**

Access this screen by using the CHAN key until reaching the desired output port number, and then by using the VIEW key until reaching this screen.

### **Diagnostic**

The screen value indicates the value presently being output from the port.

## 900 Series

### Instrument Optional Configuration

# 900 Series Navigate Option Configuration

